

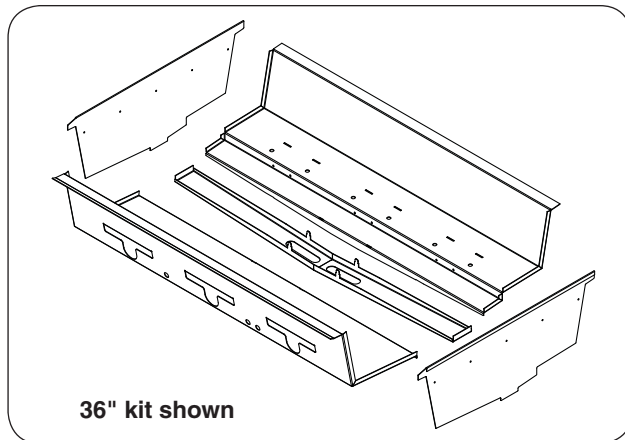

# Liner Replacement Kit

**INSTALLER:** Leave these instructions with consumer.  
**CONSUMER:** Retain for future reference.



Model	Part No.	Burners included	Igniters included
24"	24-B-41	2	2
30"	30-B-41	3	3
36"	36-B-41	3	3

Table 1

This liner kit is for replacement on AOG grills. To install, follow the steps below:

1. **Be sure the barbecue is completely cool and the gas is completely shut off.**
2. Remove the warming rack, cooking grids, vaporizer panels, burners, control panel, and igniters (see Fig. 1-1 and Fig. 1-2). Reference your owner's manual for complete removal details if needed.
3. If your vaporizer panels are being supported by tabs coming from the grill inner liner, break those tabs off using pliers as the new burners (included in this kit) provide support for the vaporizer panels.
4. Clean the interior of the grill of all deposits and grease.
5. Install the middle liner as shown in Fig. 1-3.



Fig. 1-1 Grill orientation



Fig. 1-2 Remove grill components

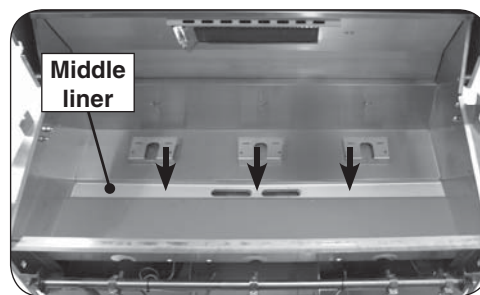

Fig. 1-3 Install middle liner

Procedure continued on next page

6. Install the rear liner as shown in Fig. 2-1, making sure the two tabs protrude through the rear liner cut outs. See Fig. 2-2.

**Note:** The top flange of the rear liner will need to slide in between the existing crease to properly rest the liner flat. Reference Fig. 2-1.

7. Install the front liner ensuring the front rests flat against the original liner wall and the two tabs protrude through the openings (see Fig. 2-3 and Fig. 2-2).

8. Install the side liner walls as shown in Fig. 2-4. Ensure they rest flat against the existing side walls. Fasten the side walls into the existing side walls using the provided self-tapping screws (5 per side wall).

**Note:** Pre-drill pilot holes into the old grill walls if needed.

**Note:** The side walls have folds on the top that are to be faced away from the grill interior.

9. Using pliers, bend in the four tabs inward toward the center of the middle liner (or twist the tabs) to lock the liner panels together. See Fig. 2-5

10. Install the new igniters (included with kit) into the front liner wall. Each igniter is to be placed from the interior of the grill, with the exposed area facing towards the burner. Fasten from the opposite side (behind face) using the included nut. Reference Fig. 2-6.

11. Install the new burners and replace any other grill components removed for this procedure.

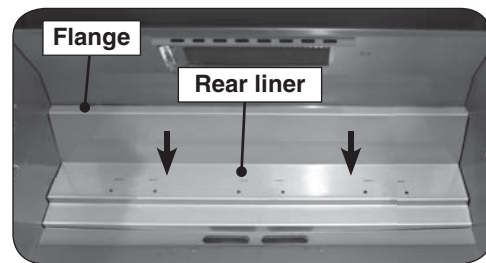

Fig. 2-1 Install rear liner

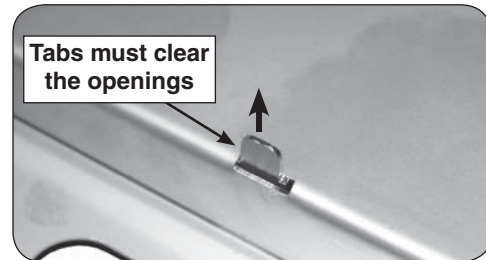

Fig. 2-2 Tabs detail

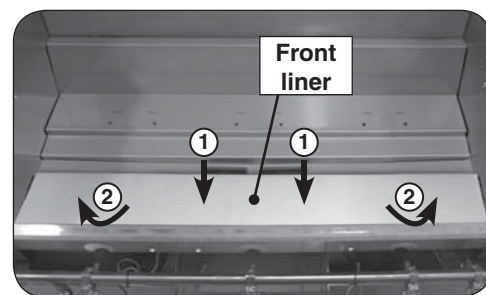

Fig. 2-3 Install front liner

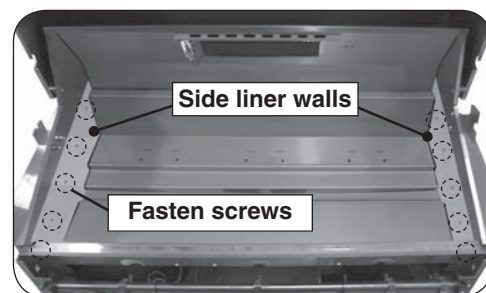

Fig. 2-4 Install side liner walls

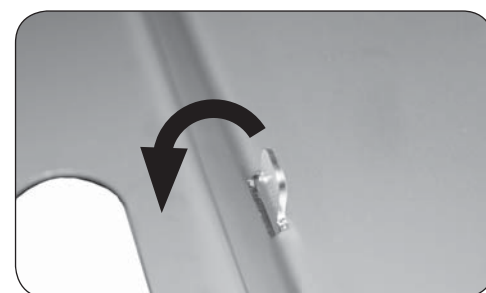

Fig. 2-5 Lock tabs

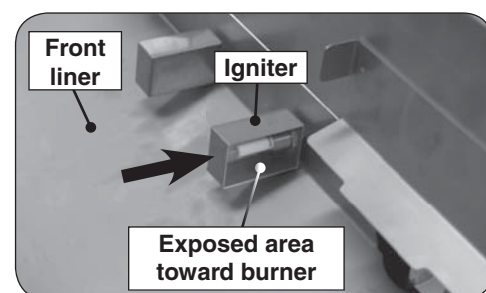

Fig. 2-6 Install igniters