



COMPACT REFRIGERATOR

3598 Series

INSTALLATION AND OWNER'S MANUAL

INSTALLER: Leave these instructions with consumer.
CONSUMER: Retain for future reference.



Important: READ THESE INSTRUCTIONS CAREFULLY BEFORE STARTING INSTALLATION OR USE. KEEP THIS MANUAL IN A SAFE PLACE AFTER READING IT.

SAFETY PRECAUTIONS AND WARNINGS

Read all of the instructions before using this appliance. When using this appliance, always exercise basic safety precautions, including the following:

Note: If the refrigerator has been placed in a horizontal or tilted position for any period of time, wait 24 hours before plugging the unit in.

- 1. Use this appliance only for its intended purpose as described in this owner's manual.
- 2. This refrigerator must be properly installed in accordance with the installation instructions before it is used. See grounding instructions in the ELECTRICAL SAFETY INFORMATION section.
- 3. Never unplug the refrigerator by pulling on the power cord. Always grasp the plug firmly and pull straight out from the outlet.
- 4. Any electric service cords that may have become frayed or damaged MUST be repaired or replaced immediately. Do not use a cord that shows any cracks or abrasion damage along its length, the plug, or the connector end.
- 5. Unplug the refrigerator before cleaning or making any repairs.

Note: If this product requires any service, it must be performed by a qualified professional service technician.

- 6. **DANGER:** Risk of Fire or Explosion. Flammable refrigerant used. Do not use mechanical devices to defrost refrigerator. Do not puncture refrigerant tubing.
- 7. If your refrigerator is not being used, it is recommended to remove the door and leave the shelves in place. This will reduce the possibility of danger to children.
- 8. Do not operate this refrigerator in the presence of explosive fumes.
- 9. This refrigerator is designed for freestanding or recessed installation.
- 10. Do not use where the supply voltage is different from the unit's requirements.
- 11. **WARNING:** If the instructions are not observed, serious injury or death may result.
- 12. Before installing the product, read the installation manual in full. The manual contains detailed instructions to be observed during installation. If you have any questions about installation, contact your dealer.
- 13. Save these instructions.

CAUTION - Risk of Fire or Explosion
Dispose of property in accordance with Federal or Local Regulations. Flammable refrigerant used.

IMPORTANT
Do Not Return This Product To The Store
If you have a problem with this product, please contact the nearest Fire Magic Dealer. For the name of nearest dealer call 626-369-5085



FIREMAGIC®

COMPACT RÉFRIGÉRATEUR Série 3598

INSTALLATION ET LE MANUEL DU PROPRIÉTAIRE

INSTALLATEUR: Laissez ces instructions avec le consommateur.

CONSOmmATEUR: Conservez pour référence ultérieure.



Important: LISEZ CES INSTRUCTIONS ATTENTIVEMENT AVANT DE COMMENCER L'INSTALLATION OU L'UTILISATION. GARDEZ CE MANUEL DANS UN LIEU SÉCURISÉ APRÈS LE LECTURE.

PRÉCAUTIONS DE SÉCURITÉ ET AVERTISSEMENTS

Lisez toutes les instructions avant d'utiliser cet appareil. Lorsque vous utilisez cet appareil, faites toujours des précautions de sécurité de base, y compris les suivantes:

Remarque: Si le réfrigérateur a été placé dans une position horizontale ou inclinée pendant une période quelconque, attendez 24 heures avant de brancher l'appareil.

1. Utilisez cet appareil uniquement pour l'usage prévu, tel que décrit dans le présent manuel d'utilisation.
2. Ce réfrigérateur doit être correctement installé conformément aux instructions d'installation avant d'être utilisé. Voir les instructions de mise à la terre dans la section ELECTRICAL SAFETY INFORMATION.
3. Ne jamais débrancher le réfrigérateur en tirant sur le cordon d'alimentation. Toujours saisir fermement la fiche et tirer tout droit de la sortie.
4. Tout cordon de service électrique qui pourrait être effiloché ou endommagé DOIT être réparé ou placé immédiatement. N'utilisez pas un cordon qui présente des fissures ou des dégâts d'abrasion sur toute sa longueur, la fiche ou l'extrémité du connecteur.
5. Débranchez le réfrigérateur avant de nettoyer ou de faire des réparations.

Remarque: Si ce produit nécessite un service, il doit être exécuté par un technicien de service professionnel qualifié.

6. **DANGER:** Risque d'incendie ou d'explosion. Liquide frigorigène inflammable utilisé. N'utilisez pas de dispositifs mécaniques pour dégivrer le réfrigérateur. Ne pas percer les tubes de réfrigérant.
7. Si votre réfrigérateur n'est pas utilisé, il est recommandé d'enlever la porte et de laisser les étagères en place. Cela réduira la possibilité de danger pour les enfants.
8. N'utilisez pas ce réfrigérateur en présence de vapeurs explosives.
9. Ce réfrigérateur est conçu pour une installation autonome ou encastrée.
10. Ne pas utiliser lorsque la tension d'alimentation est différente des exigences de l'unité.
11. **ATTENTION:** Si les instructions ne sont pas observées, des blessures graves ou mortelles peuvent en résulter.
12. Avant d'installer le produit, lisez le manuel d'installation en entier. Le manuel contient des instructions détaillées à respecter lors de l'installation. Si vous avez des questions concernant l'installation, contactez votre revendeur.
13. Enregistrez ces instructions.

IMPORTANT

Ne retournez pas ce produit à la boutique

Si vous avez un problème avec ce produit, contactez le revendeur Fire Magic le plus proche.

Pour le nom du concessionnaire le plus proche appelez le 626-369-5085

ATTENTION - Risque d'incendie ou d'explosion
Éliminer les biens conformément aux règlements fédéraux ou locaux. Liquide frigorigène inflammable utilisé.

Réfrigérateur



LISTÉ
115V~ 60Hz
Fabriqué en Chine

GETTING STARTED

SAFETY PRECAUTIONS AND WARNINGS 1

IMPORTANT INFORMATION 4

ELECTRICAL SAFETY INFORMATION 4

SPECIFICATIONS AND DIMENSIONS 5

INSTALLATION REQUIREMENTS 6

LOCATION..... 6

USE OF EXTENSION CORDS 6

PARTS LIST 7

INSTALLATION

INSTALLATION 8

UNPACK REFRIGERATOR..... 8

LOCATE REFRIGERATOR 8

LEVEL REFRIGERATOR 8

CONNECT POWER SUPPLY CORD 8

ALIGN DOOR (if needed)..... 8

REVERSE DOOR HINGE (if needed)..... 9

USE, CARE, & SERVICE

FEATURES AND USE..... 11

ADJUSTABLE TEMPERATURE DIAL..... 11

REFRIGERATOR INTERIOR SHELVES 11

WIRE CAN HOLDER COMPARTMENT 11

CRISPER 11

LOCK AND KEY 11

NORMAL OPERATING SOUNDS..... 11

CLEANING AND MAINTENANCE 12

GENERAL CLEANING 12

DOOR GASKETS 12

STAINLESS STEEL SURFACES (if applicable)..... 12

PORCELAINIZED SURFACES (if applicable)..... 12

MAINTENANCE 13

LIGHT 13

POWER INTERRUPTIONS 13

VACATION AND MOVING CARE..... 13

ENERGY SAVING TIPS 13

NOTES PAGE 14

TROUBLESHOOTING 15

WARRANTY 16

IMPORTANT INFORMATION

After removing the packing materials, check the appearance of the refrigerator for possible defects or irregularities. If the product shows any irregularity in its appearance, contact the dealer to inquire about it.

All the packing materials should not be left within reach of children and should be disposed of responsibly.

For safety, the product should be installed and used with caution in accordance with this manual. Incorrect installation or careless use of the product may cause damage or injury to the environment, humans, animals, and/or materials and property. The manufacturer does not bear any responsibility for any damage or injury.

DANGER: Risk of child entrapment. Before you throw away your old refrigerator or freezer, take off the doors. Leave the shelves in place so that children may not easily climb inside. If applicable, keep the door(s) closed with lock secured.

The refrigerator should be leveled.

When moving the product using a hand truck or dolly, place the dolly at the side of the product and shut or fix the door tightly to avoid possible opening during movement.

CAUTION: The finished bottom should be protected with a suitable material to avoid possible damage when moving the product.

The appearance, design, color, and parts of the product are subject to change without notice.

ELECTRICAL SAFETY INFORMATION

- To protect against electric shock, do not immerse cord or plugs in water or other liquid.
- Unplug from the outlet when not in use and before cleaning.
- **CAUTION: Risk of Electric Shock - Dial in "0" position does not de-energize the unit.**
- Do not operate appliance with a damaged cord, plug, or after the appliance malfunctions or has been damaged in any manner. Contact the manufacturer for repair.
- Do not let the cord touch hot surfaces.
- Do not use appliance for purposes other than intended.
- **Use only a properly wired and inspected 115VAC (15 AMP minimum) Ground Fault Circuit Interrupter (GFCI) GROUNDED 3-wire receptacle with this appliance.**
- The GFCI receptacle must be a WEATHER-PROOF IN-USE COVERED RECEPTACLE.
- Never remove the grounding plug or use with an adapter of 2 prongs.
- Do not use three prong adapters or cut off the third grounding prong in order to accommodate a two prong outlet. This is a dangerous practice since it provides no effective grounding for the refrigerator and may result in shock hazard.
- Use only extension cords with a 3 prong grounding plug, rated for the power of the equipment, and approved for outdoor use with a W-A marking.
- **The provisions of the National Electric Code as well as any local codes must be observed when installing the product.**

SPECIFICATIONS AND DIMENSIONS

Description	Specification
Input electrical requirements	115VAC / 15 Amp minimum / 60Hz / GFCI outlet
Power consumption	65-70W
Temperature setting range	32° F - 50° F
Cooling type	Compressor

Table 1 - Technical Data

	Refrigerator Models	
	3598	3598-D(L,R) 3598H-D(L,R)
A Width (door closed)	18.9"	19"
B Height (maximum, leveler legs fully <u>out</u>)	34"	34"
Height (minimum, leveler legs fully <u>in</u>)	33.25"	33.25"
C Depth (body only)	19"	19"
D Depth (door closed)	21.25"	21.25"
E Depth (door closed) w/ bar handle *	N/A	23.75"

* If equipped

Table 2 - Product Dimensions

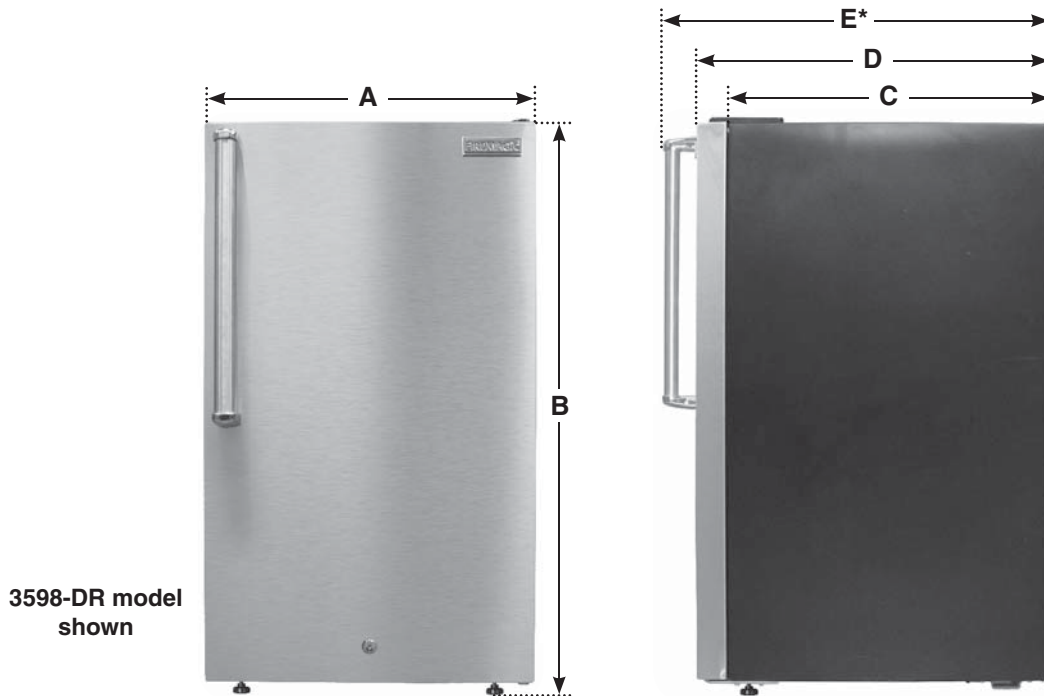

Fig. 5-1 Product dimensions

Description	Specification
Sides	3/4" (19mm)
Top	2" (50mm)
Back	2" (50mm)

Table 3 - Recommended Clearances

INSTALLATION REQUIREMENTS

LOCATION

Do not install this refrigerator in any location not properly insulated or heated, e.g. garage, etc. This refrigerator was not designed to operate in temperature settings below 55° Fahrenheit.

Select a suitable location for the refrigerator on a hard even surface away from direct sunlight or any heat source, e.g. radiators, baseboard heaters, cooking appliances, etc. Any floor unevenness should be corrected with the leveling legs located on the front bottom corners of the refrigerator.

USE OF EXTENSION CORDS

Avoid the use of an extension cord because of potential safety hazards under certain conditions. If it is necessary to use an extension cord, use only a 3-wire extension cord that has a 3-blade grounding plug and a 3-slot outlet that will accept the plug. The marked rating of the extension cord must be equal to or greater than the electrical rating of the appliance.

PARTS LIST

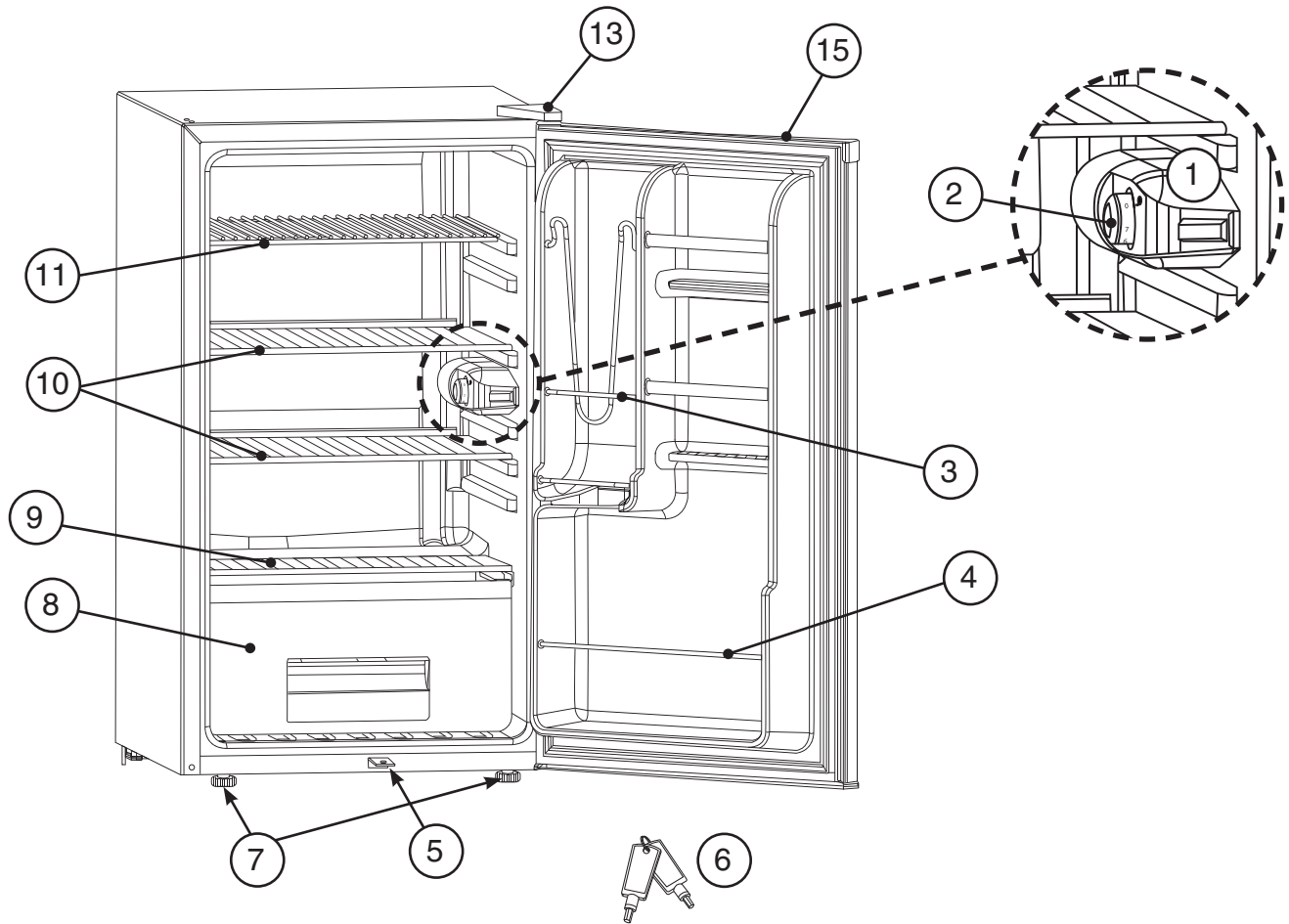

Item	Description	Part No.	Qty.
1.	Adjustable temperature control with light	-	1
2.	Thermostat knob	3598-20	1
3.	Can holder compartment	-	1
4.	Fixed door shelf (to accommodate 2-liter bottles)	-	1
5.	Lock bracket	-	1
6.	Keys (pair)	3598-21	1
7.	Adjustable front leveling legs (pair)	3598-22	1
8.	Crisper bin	3598-23	1
9.	Crisper bin glass cover	3598-24	1
10.	Slide-out glass shelf	3598-25	2
11.	Slide-out flip shelf (to accommodate tall bottles)	3598-26	1
12.	Upper door hinge assembly *	3598-27	1
13.	Upper door hinge cover	3598-28	1
14.	Lower door hinge assembly *	3598-29	1
15.	Door assembly w/ built-in top handle (reversible)	3598-10	1
or	Stainless steel door assembly w/ bar handle (left hinge)*	3598DL-10	1
or	Stainless steel door assembly w/ bar handle (right hinge)*	3598DR-10	1
or	Black Diamond Series door assembly w/ bar handle (left hinge)*	3598H-DL-10	1
or	Black Diamond Series door assembly w/ bar handle (right hinge)*	3598H-DR-10	1

* Not shown

INSTALLATION

CAUTION: Risk of Fire or Explosion due to puncturing of refrigerant tubing. Flammable refrigerant used. Handle with care when moving refrigerator to avoid either damaging the refrigerant tubing or increasing the risk of a leak.

UNPACK REFRIGERATOR

Remove all packaging material. This includes the foam base and all adhesive tape holding the refrigerator accessories inside and outside.

Inspect and remove any remains of packing, tape or printed materials before powering on the refrigerator.

LOCATE REFRIGERATOR

To ensure the refrigerator works at the maximum efficiency it was designed for, install it in a location where there is proper air circulation and electrical connections.

Important: When locating the refrigerator, be sure to follow all requirements and safety information in this manual (see the SPECIFICATIONS AND DIMENSIONS and INSTALLATION REQUIREMENTS sections).

LEVEL REFRIGERATOR

This refrigerator has two leveling legs which are located in the front bottom corners of the refrigerator. After properly placing the refrigerator in its final position, level the refrigerator.

Leveling legs can be adjusted by turning them counterclockwise to raise the refrigerator or by turning them clockwise to lower the refrigerator. The refrigerator door will close easier when the leveling legs are extended.

CONNECT POWER SUPPLY CORD

Connect the cord coming from the appliance's power supply to a **115VAC (15 AMP minimum) GFCI GROUNDED 3-wire receptacle**. The GFCI receptacle must be a WEATHER-PROOF IN-USE COVERED RECEPTACLE.

ALIGN DOOR (if needed)

1. Remove the top hinge cover.
2. Loosen the top hinge screws using a Phillips head screwdriver.
3. Adjust the door or put a spacer in between and then tighten the screws.
4. Replace the top hinge cover.

REVERSE DOOR HINGE (if needed)

Note: Refrigerator doors on 3598(H)-D(R,L) models are not reversible.

1. Remove the top hinge cover.
2. Using a Phillips Head Screwdriver, loosen and remove the screws holding the top hinge in place.
3. Remove the top hinge and carefully lift off the door.
4. Remove the screw hole plugs from the opposite side and insert the plugs in the screw hole openings of the just removed screws.
5. Remove any loose items in the refrigerator and carefully turn refrigerator on its back and place in a secure area.
6. Loosen the screws holding the lower hinge bracket to the refrigerator and remove the screws and bracket.
7. Remove (2) screws from the other side and insert in the previously removed screw holes.
8. Remove door pin by turning counter-clockwise and reinsert to the underside of the bracket and tighten.
9. Align the bracket and insert (2) remaining screws into the holes provided.
10. Align the hole in the door with the door pin and washer and gently push down until firm.
11. Align the upper hinge bracket with the screw holes, then insert screws and partially secure. Check that the door and cabinet are properly aligned, then secure tightly.
12. Replace the hinge cap.

Note: The door gets pressed in during shipping and may cause the door gasket from fully expanding to a proper seal. After reversing the door, the gasket may need to be reset. This is done to prevent the cool refrigerated air from escaping. If there is a gap between the door gasket and the cabinet, set the gasket by gently pulling it out to seal the gap.

Note: Wait 24 hours before plugging the unit in.

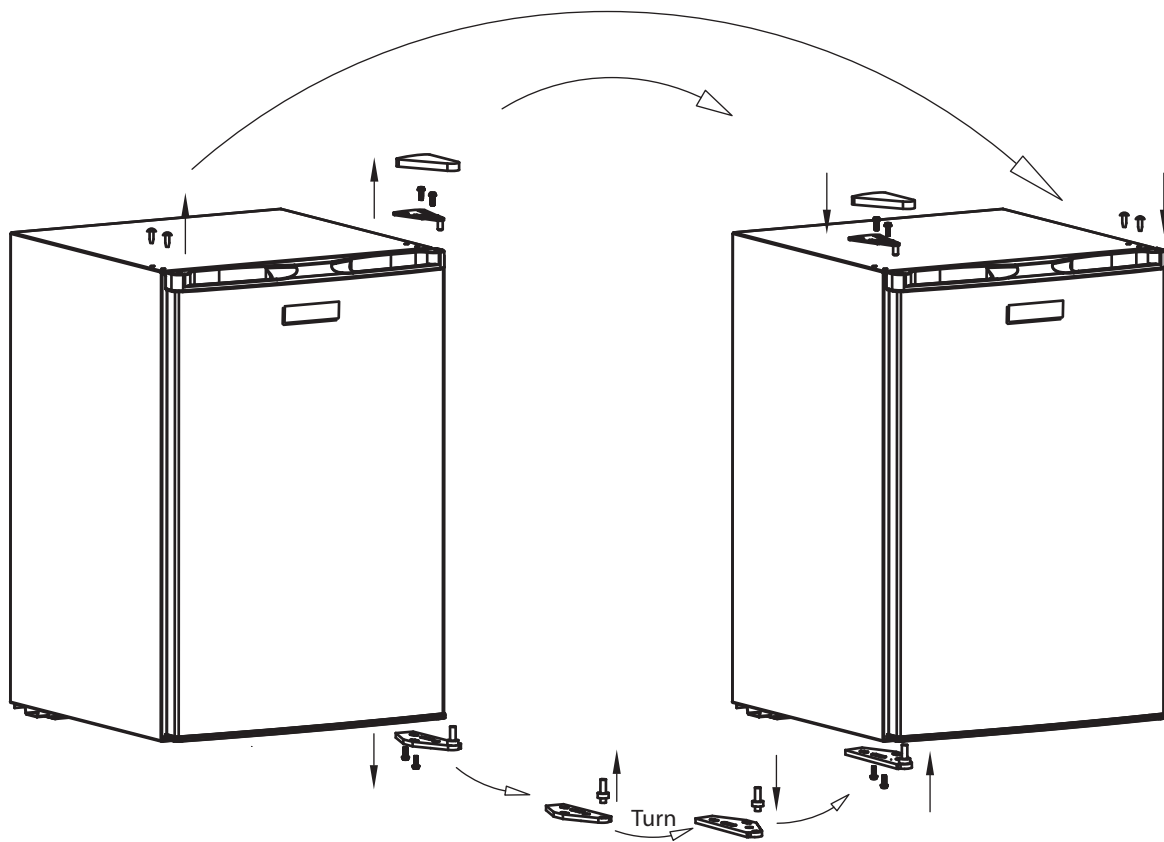

Fig. 9-1 Reverse door hinge

CARACTÉRISTIQUES ET UTILISATION

DIAL DE TEMPERATURE RÉGLABLE

Le réfrigérateur maintiendra automatiquement le niveau de température que vous choisissez. Le sélecteur de température a 7 réglages plus "0". "7" est le plus froid, "1" est le plus chaud, et "0" est zéro refroidissement. Au début, régler la molette sur "4" et laisser passer 24 heures avant de régler la température à la température désirée.

ATTENTION: Le cadran réglé sur "0" ne désactive pas l'unité.

ÉTAGÈRES INTÉRIEURES DE RÉFRIGÉRATEUR

Pour retirer ou remplacer une étagère à glissière:

- Inclinez doucement l'étagère et faites-la glisser vers l'extérieur jusqu'à ce que l'étagère soit complètement enlevée.
- Pour remplacer l'étagère, faites glisser doucement l'étagère.

Pour utiliser la tablette pivotante:

Il suffit de basculer l'étagère comme indiqué sur la Fig. 10-2. Ceci est conçu pour donner un stockage supplémentaire pour les grandes bouteilles.

COMPOSITION DE PORTE-PORTE

Le réfrigérateur est équipé d'un compartiment de porte-fil pratique. Le compartiment contient jusqu'à cinq boîtes. Il suffit de charger des canettes en haut. Pour distribuer une boîte, tirez une en bas du bas.

TIROIR

Le réfrigérateur est équipé d'un tiroir plus fin. Pour ouvrir le tiroir, agripper fermement la poignée et tirer vers l'extérieur. Faites glisser de nouveau pour fermer le tiroir-bac.

VERROUILLAGE ET CLÉ

Pour l'utiliser, insérez la clé et tournez dans le sens des aiguilles d'une montre pour verrouiller, et tournez dans le sens inverse des aiguilles d'une montre pour déverrouiller.

SONS DE FONCTIONNEMENT NORMAL

Les sons suivants sont une partie normale de l'opération:

- L'eau bouillante, les sons gargouillis ou les légères vibrations qui résultent du fait que le fluide frigorigène circule dans les serpentins de refroidissement.
- Le contrôle du thermostat cliquera quand il sera activé ou désactivé.

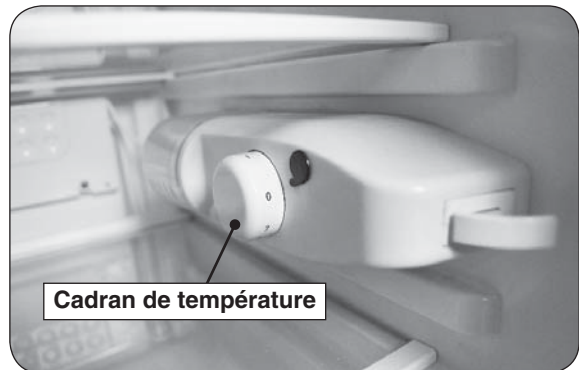

Fig. 10-1 Cadran de température réglable

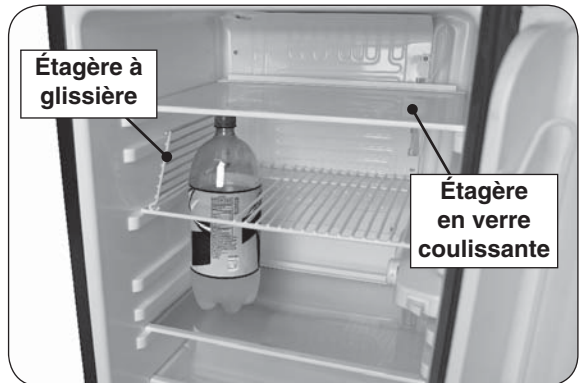

Fig. 10-2 Étagères intérieures

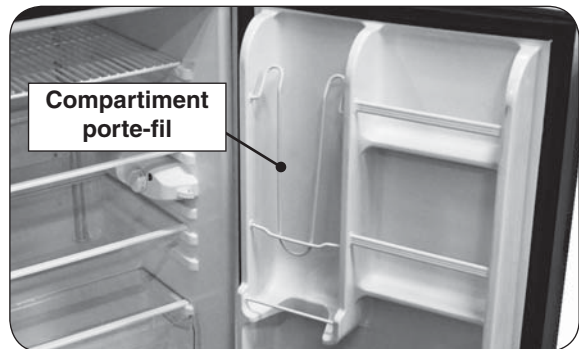

Fig. 10-3 Compartiment porte-fil

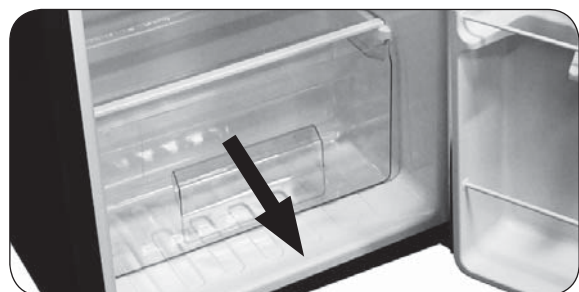

Fig. 10-4 Tiroir

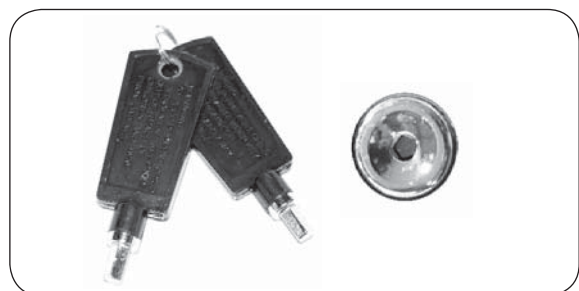

Fig. 10-5 Verrouillage et clé

ADJUSTABLE TEMPERATURE DIAL

The refrigerator will automatically maintain the temperature level you select. The temperature dial has 7 settings plus "0". "7" is the coldest, "1" is the warmest, and "0" is zero cooling. At first, set the dial to "4" and allow 24 hours to pass before adjusting the temperature to your desired temperature.

CAUTION: The dial set to "0" does not de-energize the unit.

REFRIGERATOR INTERIOR SHELVES

To remove or replace a slide-out shelf:

- Gently tilt the shelf up and slide outward until the shelf has been completely removed.
- To replace the shelf, gently slide the shelf back.

To use the slide-out flip shelf:

Simply flip the shelf as shown in Fig.11-2. This is designed to give extra storage for tall bottles.

WIRE CAN HOLDER COMPARTMENT

The refrigerator is equipped with a convenient wire can holder compartment. The compartment holds up to five cans. Simply load cans from the top. To dispense a can, draw one out from the bottom.

CRISPER

The refrigerator is equipped with a crisper bin. To open the crisper bin, grab the handle firmly and pull outward. Slide back in to close the crisper bin.

LOCK AND KEY

To use, insert the key and turn clockwise to lock, and turn counter-clockwise to unlock.

NORMAL OPERATING SOUNDS

The following sounds are a normal part of operation:

- Boiling water, gurgling sounds or slight vibrations that are the result of the refrigerant circulating through the cooling coils.
- The thermostat control will click when it cycles on and off.

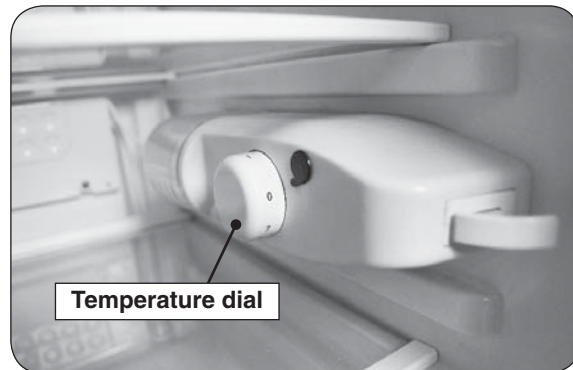

Fig. 11-1 Adjustable temperature dial

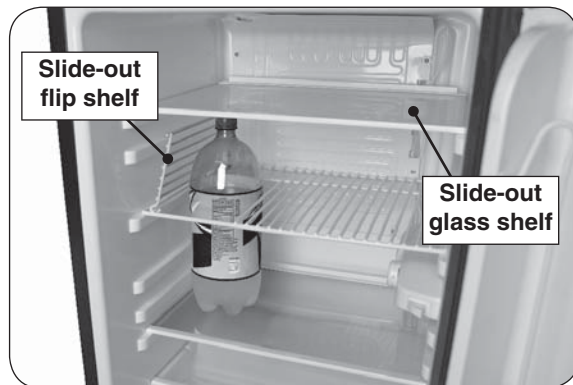

Fig. 11-2 Interior shelves

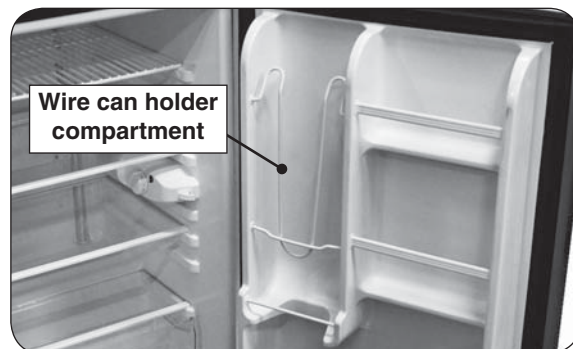

Fig. 11-3 Wire can holder compartment

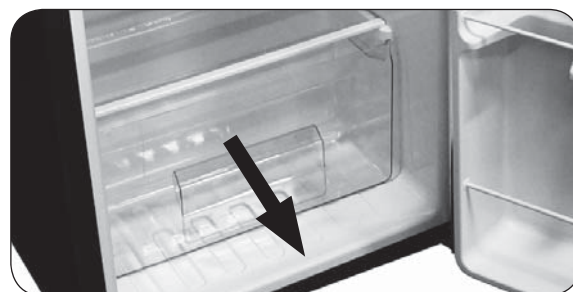

Fig. 11-4 Crisper bin

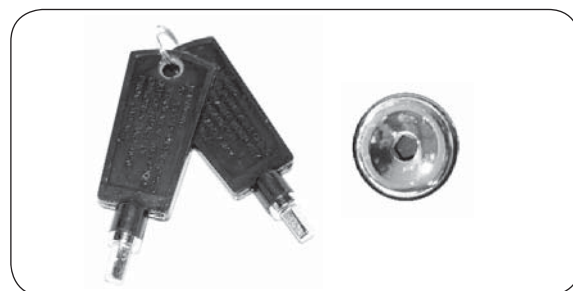

Fig. 11-5 Lock and key

CLEANING AND MAINTENANCE

All the exterior parts and interior parts of the product should be kept clean.

The refrigerator should be cleaned periodically. If the refrigerator is kept clean, its lifespan will be extended. Regular cleaning should be performed at least once a year; twice a year is recommended.

CAUTION: Before service or cleaning is performed, ensure the dial is set to "0", the power supply is disconnected, and all components of the unit are completely cool.

WARNING: To avoid electric shock, always unplug your refrigerator before cleaning. Ignoring this warning may result in death or injury.

CAUTION: Before using cleaning products, always read and follow manufacturer's instructions and warnings to avoid personal injury or product damage.

GENERAL CLEANING

Prepare a cleaning solution of 3-4 tablespoons of baking soda mixed with warm water. Use sponge or soft cloth, dampened with the cleaning solution, to wipe down your refrigerator.

Rinse with clean warm water and dry with a soft cloth.

Do not use harsh chemicals, abrasives, ammonia, chlorine bleach, concentrated detergents, solvents or metal scouring pads. Some of these chemicals may dissolve, damage and/ or discolor your refrigerator.

DOOR GASKETS

Clean door gaskets every three months using cleaning solution and non-abrasive cloths or pads. Gaskets must be kept clean and pliable to ensure a proper seal.

Petroleum jelly applied lightly on the hinge side of gaskets will keep the gasket pliable and ensure a good seal.

STAINLESS STEEL SURFACES (if applicable)

The exterior of the appliance should be cleaned by first using stainless steel cleaner to remove grease and dirt. Always wipe with the grain (see Fig. 12-1). Next, apply stainless steel polish and wipe down using polish wipes to restore the stainless steel color.

PORCELAINIZED SURFACES (if applicable)

Refrigerator doors that are porcelainized provide many years of trouble-free service. These surfaces may be cleaned with non-corrosive oven/grill cleaner, following manufacturer's instructions.



Fig. 12-1 Wipe with grain

MAINTENANCE

DANGER: Risk of Fire or Explosion due to puncturing of refrigerant tubing. Flammable refrigerant used. Do not use metal instruments to defrost refrigerator. Do not puncture refrigerant tubing.

- All safety precautions must be followed.
- To be repaired only by a qualified professional service technician.

LIGHT

To replace the bulb, carefully pull the plastic light cover to the left and remove. Locate and unscrew the bulb and replace it with a new bulb (use bulbs of 15 watts or less). Replace plastic light cover.

POWER INTERRUPTIONS

Occasionally there may be power interruptions due to thunderstorms or other causes. Remove the power cord from GFCI outlet when a power outage occurs. When power has been restored, reconnect power cord to GFCI outlet. If outage is for a prolonged period, inspect and discard spoiled or thawed food in refrigerator. Clean refrigerator before reusing.

VACATION AND MOVING CARE

For long vacations or absences, empty food from refrigerator and freezer, move the temperature dial to the "0" position and clean the refrigerator and door gaskets (see previous page). Prop doors open, so air can circulate inside. When moving, always move the refrigerator vertically. Do not move with the unit lying down. Possible damage to the sealed system could occur.

ENERGY SAVING TIPS

- The refrigerator should be located in the coolest area of the room, away from heat-producing appliances or heating ducts, and out of direct sunlight.
- Let hot foods cool to room temperature before placing in the refrigerator. Overloading the refrigerator forces the compressor to run longer and thus increases energy consumption. Foods that refrigerate too slowly may lose quality or spoil.
- Be sure to wrap foods properly, and wipe containers dry before placing in the refrigerator.
- The wire shelves should not be lined with aluminum foil, wax paper, or paper towels. Liners interfere with cold air circulation, making the refrigerator less efficient.
- Organize food to reduce door openings and extended searches. Remove as many items as needed at one time, and close the door as soon as possible.

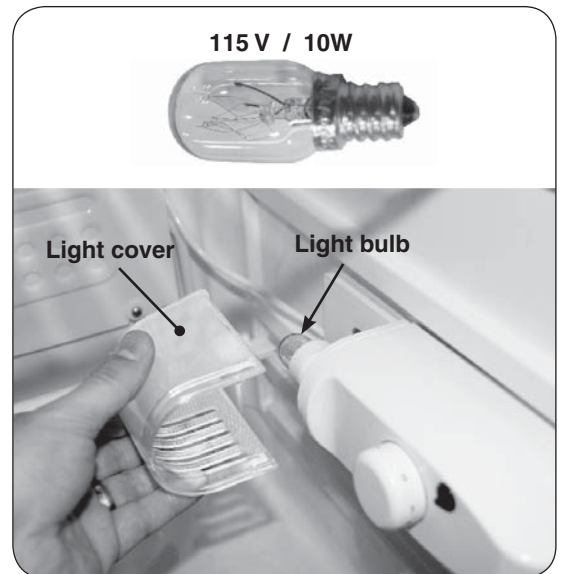

Fig. 13-1 Replace light bulb

Please use this page to record any information that you may want to have at hand.

TROUBLESHOOTING

PROBLEM	POSSIBLE CAUSE	CORRECTION
Refrigerator does not operate	<ol style="list-style-type: none"> 1. Dial turned to "0" 2. Refrigerator is unplugged 3. Breaker tripped 	<ol style="list-style-type: none"> 1. Turn dial past "0". 2. Plug the refrigerator in. 3. Reset GFCI outlet and/or the main breaker. If it happens again, call an authorized service center.
Food temperature appears too warm	<ol style="list-style-type: none"> 1. Frequent door openings 2. Food not allowed enough time to cool 3. Door gaskets not properly sealed 4. Temperature setting is too low 	<ol style="list-style-type: none"> 1. Keep door openings to a minimum to prevent cool air from escaping. 2. Allow time for recently added warm food to reach fresh food temperature. 3. Check gaskets for proper seal. See the CLEANING AND MAINTENANCE, DOOR GASKETS section. 4. Adjust temperature dial to colder setting.
Food temperature is too cold	<ol style="list-style-type: none"> 1. Temperature setting is too high 	<ol style="list-style-type: none"> 1. Adjust temperature dial to warmer setting.
Refrigerator runs too frequently	<ol style="list-style-type: none"> 1. Hot and humid conditions 2. Prolonged or frequent door openings 3. Door gaskets not properly sealed 4. Door not completely closed 	<ol style="list-style-type: none"> 1. This may be normal to maintain constant temperature during high temperatures and humid days. 2. Keep door openings to a minimum and keep open for short amounts of time. 3. Check gaskets for proper seal. See the CLEANING AND MAINTENANCE, DOOR GASKETS section. 4. Check to see if door is completely closed.
Moisture build up on interior or exterior of the refrigerator	<ol style="list-style-type: none"> 1. Humid conditions 2. Prolonged or frequent door openings 3. Door gaskets not properly sealed 	<ol style="list-style-type: none"> 1. This is normal during high humidity periods. 2. Keep door openings to a minimum and keep open for short amounts of time. 3. Check gaskets for proper seal. See the CLEANING AND MAINTENANCE, DOOR GASKETS section.
Refrigerator has an odor	<ol style="list-style-type: none"> 1. Interior needs cleaning 2. Foods improperly wrapped or sealed are giving off odors 	<ol style="list-style-type: none"> 1. Clean the interior. See the CLEANING AND MAINTENANCE section. 2. Properly wrap and seal foods.
Refrigerator door does not shut properly	<ol style="list-style-type: none"> 1. Unit not level 2. Door out of alignment 3. Foods not properly stored 	<ol style="list-style-type: none"> 1. Level the refrigerator. See INSTALLATION, LEVEL REFRIGERATOR section. 2. Align the refrigerator door. See INSTALLATION, ALIGN DOOR section. 3. Check for blockages, e.g. food containers, crisper cover, shelves, bins, etc.
Popping or cracking sound when the compressor comes on	<ol style="list-style-type: none"> 1. Unit not level 2. The floor is uneven or weak 3. The refrigerator rocks on the floor when it is moved slightly. 4. The refrigerator is touching the wall. 	<ol style="list-style-type: none"> 1. Level the refrigerator. See INSTALLATION, LEVEL REFRIGERATOR section. 2. Ensure the floor is even and can adequately support the refrigerator. 3. Ensure the floor is even. 4. Move the refrigerator from the wall.

WARRANTY

ONE-YEAR WARRANTY - Fire Magic® electric accessories are warranted for one year from the date of purchase.

A COPY OF YOUR SALES SLIP FOR PROOF OF PURCHASE IS REQUIRED

This warranty applies to the original purchaser for products which are installed in the United States or Canada and which are operated and maintained as intended for single family residential usage. This warranty is valid only with proof of purchase, shall commence on the date of purchase, and shall terminate (both as to original and any replacement products) on the anniversary date of the original purchase of the product stated on the above schedules.

This warranty covers defects in material and workmanship. This warranty **does not** cover parts which become defective as a result of negligence, misuse, use not in compliance with the Owner's Manual/Installation Instructions, accidental damage, improper handling, improper storage, improper installation, **lack of required routine maintenance** (as specified in the Owner's Manual/Installation Instructions), or electrical damage. Product must be installed as specified in the Owner's Manual/Installation Instructions by a **qualified professional installer**. Modifications to products which are not specifically authorized will void this warranty. Accessories, parts, valves, remotes, etc. when used must be Peterson products or this warranty is void. Warrantied items will be repaired or replaced at Peterson's sole discretion. This warranty **does not** apply to rust, corrosion, oxidation, or discoloration unless the affected part becomes inoperable.

This warranty **does not** cover labor or labor related charges, except as provided by separate specific written programs from the Peterson Co. All repair work must be performed by a qualified professional service person and requires prior approval of Peterson.

Peterson may require the defective product or part to be returned to the factory to determine the cause of failure. Peterson will pay freight charges if the product or part is determined to be defective. This warranty does not cover breakage in shipment from our (Independent) distributor to its customer if the damage is determined to have occurred during that shipment.

This warranty specifically excludes liability for **indirect, incidental**, or consequential damages. Some states and provinces do not allow the exclusion or limitation of incidental or consequential damages, so the above exclusion may not apply to you. This warranty gives you specified legal rights, and you may have other rights that vary from state to state or province.

For additional information regarding this warranty, or to place a warranty claim, contact the R. H. Peterson dealer where the product was purchased.

When contacting your Peterson dealer or the R. H. Peterson Co., please provide the following information:

- Your name, address, telephone number, e-mail
- Sales receipt showing where purchased and date purchased
- Model number, serial number of product, date code
- Relevant information: installer, additions, repairs, when defect was first noted

**TO REGISTER YOUR PRODUCT ONLINE GO TO: WWW.RHPETERSON.COM,
AND CLICK ON PRODUCT REGISTRATION. THANK YOU FOR YOUR PURCHASE.**