



Burner Systems:

- G22-GL-2-18(G)-01(M)(P)
- G22-GL-2-24(G)-01(M)(P)
- G22-GL-2-30(G)-01(M)(P)



DESIGN CERTIFIED
to
Vented Decorative Appliance
ANSI Z21.60-2012
CSA 2.26-2012

FOR USE WITH
FYRE GLASS / FYRE GEMS

18"	12.5 lbs
24"	17.5 lbs
30"	20.0 lbs

**FOR INSTALLATION IN
SEE-THRU SOLID-FUEL
BURNING FIREPLACES***

**FOR INDOOR OR
OUTDOOR USE**

G22-GL-2 VENTED BURNER SYSTEMS

WARNING

If the information in this manual is not followed exactly, a fire or explosion may result, causing property damage, personal injury, or loss of life.

Do not store or use gasoline or other flammable vapors and liquids in the vicinity of this or any other appliance.

WHAT TO DO IF YOU SMELL GAS:

- Open a window.
- Do not try to light any appliance.
- Do not touch any electrical switch; do not use any phone in the building.
- Immediately call the gas supplier from a neighbor's phone. Follow gas supplier's instructions.
- If you cannot reach the gas supplier, call the fire department.

Installation and service must be performed by a qualified professional installer, service agency, or the gas supplier.

This appliance is only for use with the type of gas indicated on the rating plate.

IMPORTANT: READ THESE INSTRUCTIONS CAREFULLY BEFORE STARTING INSTALLATION OF THE UNIT.

The Real-Fyre burner system is to be installed only in a solid-fuel burning fireplace with a working flue and constructed of noncombustible material. The installation, including provisions for combustion and ventilation air must conform with the *National Fuel Gas Code, ANSI Z223.1/NFPA 54*, or the *CSA B149.1, Natural Gas and Propane Installation Code*, and applicable local building codes.

A damper clamp is included to maintain the minimum permanent vent opening and to prevent full closure of the damper blade. **The chimney damper MUST be fully opened when burning the unit. The unit is designed to burn with yellow flames; thus adequate ventilation is absolutely necessary.**

To comply with certification, listings, and building code acceptances, and for safe operation and proper performance of this burner system, use ONLY Peterson parts and accessories. Use of other controls, parts, and accessories that are not designed for use with Real-Fyre burner systems is prohibited and will void all warranties, certifications, listings, and building code approvals, and may cause property damage, personal injury, or loss of life.

***Note:** Solid-fuels shall not be burned in a fireplace where a decorative appliance is installed.



We recommend that our gas hearth products be installed and serviced by professionals who are certified in the U.S. by the National Fireplace Institute® (NFI) as NFI Gas Specialists.

INSTALLER:
Leave this manual with the appliance.
CONSUMER:
Retain this manual for future reference.



12-021

Systèmes De Brûleur:

- G22-GL-2-18(G)-01(M)(P)
- G22-GL-2-24(G)-01(M)(P)
- G22-GL-2-30(G)-01(M)(P)

POUR L'USAGE AVEC
 FYRE GLASS / FYRE GEMS

18"	12.5 lbs
24"	17.5 lbs
30"	20.0 lbs



CONCEPTION CERTIFIÉE
 à

Vented Decorative Appliance
 ANSI Z21.60-2012
 CSA 2.26-2012

**POUR L'INSTALLATION DANS
 LE COMBUSTIBLE SOLIDE
 DE SEE-THRU BRÛLANT
 FIREPLACES***

**POUR L'USAGE D'INTÉRIEUR
 OU EXTÉRIEUR**

G22-GL-2 SYSTÈMES EXHALÉS DE BRÛLEUR

AVERTISSEMENT

Si l'information en ce manuel n'est pas suivie exactement, une incendie ou une explosion peut résulter, entraînant des dégâts matériels, des blessures, ou la perte de la vie.

Ne stockez pas ou n'employez pas l'essence ou d'autres vapeurs et liquides inflammables à proximité de ceci ou d'aucun autre appareil.

CE QUI À FAIRE SI VOUS SENTEZ LE GAZ:

- Ouvrez une fenêtre.
- N'essayez pas de n'allumer aucun appareil.
- Ne touchez aucun commutateur électrique; n'utilisez aucun téléphone dans le bâtiment.
- Appelez immédiatement le fournisseur de gaz du téléphone du voisin. Suivez les instructions du fournisseur de gaz.
- Si vous ne pouvez pas atteindre le fournisseur de gaz, appelez le département de feu.

L'installation et le service doivent être assurés par un installateur qualifié et professionnel, l'agence de service, ou le fournisseur de gaz.

Cet appareil sert seulement avec le type de gaz indiqué de la plaque de contrôle.

INSTALLATEUR :

Laissez ce manuel avec l'appareil.

CONSOMMATEUR:

Maintenez ce manuel pour la future référence.



IMPORTANT: LISEZ CES INSTRUCTIONS SOIGNEUSEMENT AVANT DE COMMENCER L'INSTALLATION DE L'UNITÉ.

Le Vrai-Fyre système de brûleur doit être installé seulement dans une cheminée brûlante de combustible solide avec une conduite de cheminée fonctionnante et être construit avec du matériel non-combustible. L'installation, y compris des dispositions pour l'air de combustion et de ventilation doit se conformer au code national de gaz de carburant, la norme ANSI Z223.1/ NFPA 54, ou le CSA B149.1, code d'installation de gaz naturel et de propane, et codes du bâtiment locaux applicables.

Une bride plus humide est incluse pour maintenir l'ouverture permanente minimum de passage et pour empêcher la pleine fermeture de la lame plus humide. **L'amortisseur de cheminée DOIT être entièrement ouvert en brûlant l'unité. L'unité est conçue pour brûler avec les flammes jaunes; ainsi à ventilation proportionnée est absolument nécessaire.**

Pour se conformer à la certification, les listes, et les acceptations de codes du bâtiment, et pour l'exploitation sûre et l'exécution appropriée de ce système de brûleur, utilisent SEULEMENT des pièces et des accessoires de Peterson. L'utilisation d'autres commandes, pièces, et accessoires qui ne sont pas conçus pour l'usage avec de Real-Fyre systèmes de brûleur est interdite et videra toutes les garanties, certifications, listes, et approbations de codes du bâtiment, et peut causer des dégâts matériels, le dommage corporel, ou des pertes humaines.

***Note:** des Plein-carburants ne seront pas brûlés dans une cheminée où un appareil décoratif est installé.

TABLE OF CONTENTS

5	IMPORTANT PRE-INSTALLATION AND FIREPLACE SAFETY INFORMATION
6	SPECIFICATIONS
6	DAMPER CLAMP INSTRUCTIONS
7	BURNER PARTS LIST - REMOTE MODEL
8	BURNER PARTS LIST - MANUAL MODEL
9	BURNER INSTALLATION
10	REMOTE SYSTEM (if equipped)
11	DECORATIVE MEDIA PLACEMENT
11	GLASS/GEMS PLACEMENT (purchased separately)
11	DECORATIVE MEDIA ON FIREPLACE FLOOR (optional)
12	INSTALLING/REPLACING BATTERIES
12	REMOTE TRANSMITTER BATTERY
12	REMOTE RECEIVER BATTERIES AND/OR REMOTE RECEIVER BOX BATTERIES
12	SWITCH BOX BATTERIES
13	LIGHTING INSTRUCTIONS - REMOTE MODEL
13	MANUAL LIGHTING
13	REMOTE LIGHTING
15	PILOT APPEARANCE
15	SHUTTING DOWN
17	LIGHTING INSTRUCTIONS - MANUAL MODEL
17	PILOT APPEARANCE
17	SHUTTING DOWN
19	CLEANING AND SERVICING SAFETY INFORMATION
19	FLAME DESCRIPTION
19	TO CLEAN THE BURNER SYSTEM
20	NOTES PAGE
21	TROUBLESHOOTING
23	ELECTRONIC PILOT TROUBLESHOOTING
24	WARRANTY

L'INFORMATION DE SÛRETÉ IMPORTANTE DE PRÉINSTALLATION ET DE CHEMINÉE

ATTENTION: L'installation et la réparation doivent être faites par un NFI certifié ou tout autre installateur professionnel qualifié.

Installateur: Lisez soigneusement ces instructions avant d'installer ce système de brûleur à gaz. Soyez sûr que vous comprenez tous les mesures de sécurité et avertissements contenus en ce manuel.

- A.** Cet appareil est conçu comme appareil occupé. Les adultes doivent être présent quand cet appareil à gaz fonctionne. Ne laissez pas ce burning d'unité si sans surveillance ou tandis que n'importe qui dort.
- B.** Cet appareil sert seulement avec le type de gaz indiqué de la plaque de contrôle. Cet appareil n'est pas CONVERTIBLE de CHAMP pour l'usage avec d'autres gaz.
- C. FAITES ATTENTION: Sinon installé, entretenu, et utilisé correctement par ces instructions, ce produit peut causer le dommage corporel, les dégats matériels, ou les pertes humaines sérieux.**
- D. AVERTISSEMENT:** Avant l'installation dans une cheminée plein-carburant-brûlante, la conduite de cheminée, l'amortisseur, et le foyer de cheminée doivent ÊTRE COMPLÈTEMENT NETTOYÉS de la suie, de la créosote, des cendres, et de la peinture lâche, et doivent être inspectés par un décapant qualifié de cheminée. Quelques cheminées plus anciennes peuvent ont besoin de réparation avant d'installer cet appareil.
- E. VÉRIFIEZ LE TYPE de GAZ (normal ou propane) :** La fourniture de gaz doit être identique qu'indiquée de votre plaque de contrôle de système de brûleur. Si la fourniture de gaz est différente, **N'INSTALLEZ PAS**. Contactez votre revendeur pour l'aide immédiate.
- F.** Gardez le domaine du clair réglé de notation de gaz et libérez des matériaux combustibles, l'essence, et d'autres vapeurs et liquides inflammables.
- G. LA PRESSION DE GAZ INSUFFISANTE GARDERA LE PILOTE DU FONCTIONNEMENT CORRECTEMENT (SI ÉQUIPÉ). N'EMPLOYEZ PAS SI LA PRESSION DE GAZ EST INFÉRIEURE À LA CONDITION MINIMUM.**
- H.** L'admission minimum gaz-fournissent la pression aux fins de l'ajustement d'entrée est 5" ; colonne d'eau (w.c.) sur le gaz naturel et le 11" ; w.c. sur le gaz de propane. La pression de gaz insuffisante affectera l'opération appropriée du pilote (si équipé). N'installez pas cet appareil à gaz si la pression minimum n'est pas disponible. L'admission maximum gaz-fournissent la pression est 10.5" ; w.c. sur le gaz naturel et le 13" ; w.c. sur le gaz de propane. La source de propane doit être réglée. **(Ne pas connecter cet appareil directement à un réservoir de gaz propane non -. Cela peut provoquer une explosion) Ne pas brancher cet appareil à une bouteille de gaz propane portable.**
- I. Le système sifflant de gaz doit être classé pour fournir la pression d'admission minimum au débit maximum (BTU/hr).** La perte de pression anormale se produira si la pipe est trop petite, ou la course est trop longue. La pipe de fourniture de gaz doit être 1/2" ; diamètre intérieur minimum. Si la ligne de gaz est plus longue que 20' ; une ligne de plus grand diamètre peut être nécessaire. Reportez-vous aux directives NFPA 54 pour plus de détails.
- J.** Les estimations d'entrée montrées en Btu par heure sont pour des altitudes jusqu'à 2.000 pi. Pour des altitudes au-dessus de 2.000 pi, référez-vous au code national de gaz de carburant ou entrez en contact avec le fabricant avant d'installer ce produit.
- K.** Cet appareil à gaz et son clapet à gaz principal doivent être disconnected du gaz-fournissent le système sifflant pendant tout vérificateur de pression de ce système aux pressions d'essai au-dessus de 1/2 psig.
- L.** Cet appareil à gaz doit être isolé dans gaz-fournissent le système sifflant en fermant le robinet d'isolement d'équipement relié au gaz-fournissent la ligne pendant tout vérificateur de pression du gaz-fournissent le système sifflant aux pressions d'essai égales à ou moins d'à 1/2 psig.
- M.** N'employez pas cet appareil si n'importe quelle partie a été sous-marine. Appelez immédiatement un technicien qualifié de service pour inspecter l'appareil et pour remplacer n'importe quelle partie du système de contrôle et de n'importe quelle commande de gaz qui a été sous-marine.
- N. Una pantalla de la chimenea debe ser en el lugar cuando el sistema está quemando.** Las provisiones para el aire de combustión adecuado deben ser mantenidas. A menos que otras provisiones para el aire de combustión se proporcionen, la pantalla tendrá una abertura para la introducción de aire de combustión. El aire de combustión es adecuado cuando todas las llamas se encrespan en la chimenea y lejos de la pantalla. **Cuando se utiliza un recinto de cristal de la chimenea (puerta), deje las puertas completamente abiertas cuando el sistema es en funcionamiento.**
- O.** Cet appareil peut être installé dans un marché des accessoires, maison (mobile) de manière permanente située et manufacturée, ou non interdit par des codes locaux. L'installation des appareils a conçu pour la maison manufacturée (États-Unis seulement) ou installation de caravane résidentielle doit se conformer au CAN/CSA standard Z240 MH, logement mobile, au Canada, ou à la construction et au standard de sécurité à la maison manufacturés, intitulent 24 CFR, la partie 3280, aux Etats-Unis, ou quand une telle norme ne s'applique pas, à ANSI/NCSBCS A225.1/NFPA 501A, installations à la maison manufacturées standard.
- P. LE VERRE OU LES GEMMES DE PETERSON (VRAI FYRE) SONT LES SEULS MÉDIAS CERTIFIÉS POUR ÊTRE EMPLOYÉ DANS CE BRÛLEUR. N'EMPLOYEZ AUCUN AUTRE MILIEU.** L'installation correcte du verre/gemmes et le placement et l'installation appropriés du brûleur, sont impérative à l'exploitation sûre de votre appareil. Les problèmes se poseront si tous les articles ne sont pas correctement installés.
- Q.** La quantité correcte de verre/de gemmes doit être employée sur votre système de brûleur pour qu'elle fonctionne correctement. Vous pouvez employer le verre/gemmes additionnels, ou des granules de lave pour couvrir le plancher de la cheminée. Veuillez lire la section DÉCORATIVE entière de PLACEMENT de MÉDIAS pour des détails.

IMPORTANT PRE-INSTALLATION AND FIREPLACE SAFETY INFORMATION

CAUTION: Installation and repair must be done by an NFI Certified or other qualified professional installer.

Installer: Carefully read these instructions before installing this gas burner system. Be sure you understand all safety precautions and warnings contained in this manual.

- A. This appliance is designed as an **attended appliance**. Adults must be present when this gas appliance is operating. Do not leave this unit burning when unattended or while anyone is sleeping.
- B. This appliance is only for use with the type of gas indicated on the rating plate. This appliance is **NOT FIELD CONVERTIBLE** for use with other gasses.
- C. **BE CAREFUL: If not installed, serviced, and used correctly per these instructions, this product can cause serious personal injury, property damage, or loss of life.**
- D. **WARNING:** Before installing in a solid-fuel-burning fireplace, the chimney flue, damper, and firebox must be thoroughly CLEANED of soot, creosote, ashes, and loose paint, and must be inspected by a qualified chimney cleaner. Some older fireplaces may need repair prior to installing this appliance.
- E. CHECK GAS TYPE (natural or L.P.): The gas supply must be the same as stated on your burner system rating plate. If gas supply is different, **DO NOT INSTALL**. Contact your dealer for immediate assistance.
- F. Keep the area of the gas burner system clear and free from combustible materials, gasoline, and other flammable vapors and liquids.
- G. INSUFFICIENT GAS PRESSURE WILL KEEP THE PILOT (IF EQUIPPED) FROM OPERATING PROPERLY. DO NOT USE IF GAS PRESSURE IS LOWER THAN THE MINIMUM REQUIREMENT.
- H. The *minimum* inlet gas-supply pressure for purposes of input adjustment is **5"** water column (w.c.) on **natural gas** and **11"** w.c. on **L.P. gas**. Insufficient gas pressure will affect proper operation of the pilot (if equipped). Do not install this gas appliance if minimum pressure is not available. The *maximum* inlet gas-supply pressure is **10.5"** w.c. on natural gas and **13"** w.c. on L.P. gas. The L.P. source must be regulated. **(Do not connect this appliance directly to an unregulated L.P. gas tank - this can cause an explosion.) Do not connect this appliance to a portable L.P. gas cylinder.**
- I. **The gas piping system must be sized to provide minimum inlet pressure at the maximum flow rate (BTU/hr).** Undue pressure loss will occur if the pipe is too small, or the run is too long. Gas supply pipe must be 1/2" minimum interior diameter. If the gas line is longer than 20', a larger diameter line may be necessary. Refer to the NFPA 54 guidelines for further details.
- J. Input ratings shown in BTU per hour are for elevations up to 2,000 ft. For elevations above 2,000 ft., refer to the National Fuel Gas Code or contact manufacturer before installing this product.
- K. This gas appliance and its main gas valve must be disconnected from the gas-supply piping system during any pressure testing of that system at test pressures in excess of 1/2 psig.
- L. This gas appliance must be isolated from the gas-supply piping system by closing the equipment shutoff valve connected to the gas-supply line during any pressure testing of the gas-supply piping system at test pressures equal to or less than 1/2 psig.
- M. Do not use this appliance if any part has been underwater. Immediately call a qualified service technician to inspect the appliance and to replace any part of the control system and any gas control that has been underwater.
- N. **A fireplace screen must be in place when the system is burning.** Provisions for adequate combustion air must be maintained. Unless other provisions for combustion air are provided, the screen shall have an opening(s) for introduction of combustion air. Combustion air is adequate when all flames curl into the fireplace and away from the screen. **When a glass fireplace enclosure (door) is used, leave the doors fully open when the system is in operation.**
- O. This appliance may be installed in an aftermarket, permanently located, manufactured (mobile) home, where not prohibited by local codes. Installation of appliances designed for manufactured home (U.S. only) or mobile home installation must conform with the Standard *CAN/CSA Z240 MH, Mobile Housing*, in Canada, or with the *Manufactured Home Construction and Safety Standard, Title 24 CFR, Part 3280*, in the United States, or when such a standard is not applicable, *ANSI/NCSCS A225.1/NFPA 501A, Manufactured Home Installations Standard*.
- P. PETERSON (REAL FYRE) GLASS OR GEMS ARE THE ONLY MEDIA CERTIFIED TO BE USED IN THIS BURNER. **DO NOT USE ANY OTHER MEDIA.** Correct installation of the glass/gems and proper placement and installation of the burner assembly, are imperative to safe operation of your appliance. Problems **WILL** occur if all items are not properly installed.
- Q. The correct amount of glass/gems **must** be used on your burner system for it to operate properly. You may use additional glass/gems, or lava granules to cover the floor of the fireplace. Please read the entire DECORATIVE MEDIA PLACEMENT section for details.

SPECIFICATIONS

Real-Fyre gas burner systems must be installed only in a wood burning fireplace with the minimum firebox dimensions and venting requirements met (see table on this page). This appliance is designed to burn with yellow flames; adequate ventilation is absolutely necessary.

Burner Model	Minimum Fireplace Size			BTU Rating	
	Width	Depth	Height	Natural Gas	Propane Gas
G22-GL-2-18(G)-01(M)(P)	27"	16"	15"	45k	40k
G22-GL-2-24(G)-01(M)(P)	33"	16"	15"	55k	50k
G22-GL-2-30(G)-01(M)(P)	39"	16"	15"	70k	65k

Minimum permanent free opening area of chimney damper for venting (sq. in.)			
For factory-built fireplaces *			
Chimney height	18"	24"	30"
15'	20	24	33
20'	17	21	23
30'	13	16	21

* For masonry-built fireplaces, add 5 sq. in. to amount shown

Note: The minimum chimney height from hearth to top of chimney is 15'.

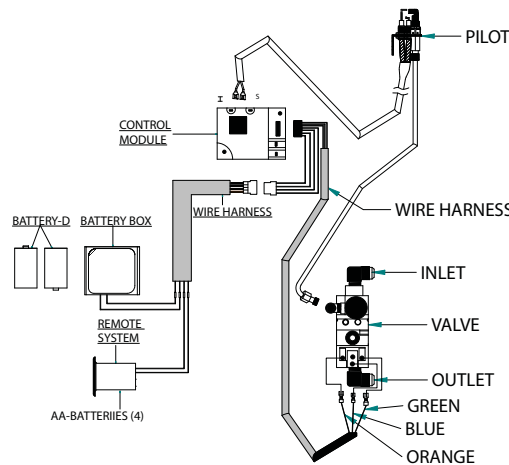

(Remote model shown)

Wiring Diagram
Fig. 6-1

DAMPER CLAMP INSTRUCTIONS

The damper clamp with hex bolt (Fig. 6-2) is provided as a means to prevent full closure of the damper blade. The clamp is easily attached to most damper blades with pliers or a wrench, and must be permanently installed. The clamp is designed to prevent accidental closure of the damper when installed as illustrated (Fig. 6-3 and Fig. 6-4). Should the clamp not fit, or fail to provide the permanent vent opening listed in the table found above, have a permanent stop installed, remove the damper blade, or have the damper cut to provide the minimum permanent opening required.

Note: These are minimum damper opening specifications. The damper must be completely opened when operating this gas appliance to achieve the best ventilation possible.

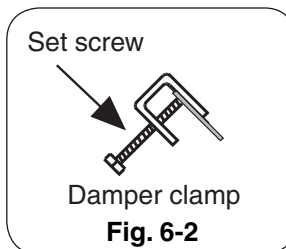
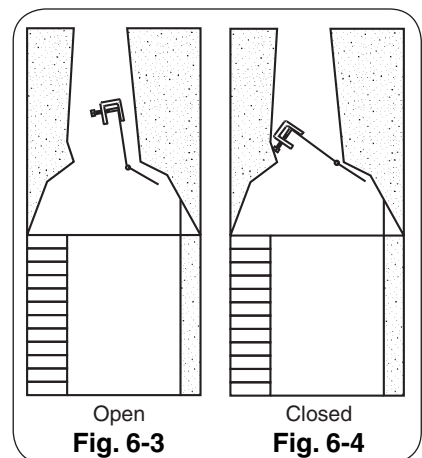
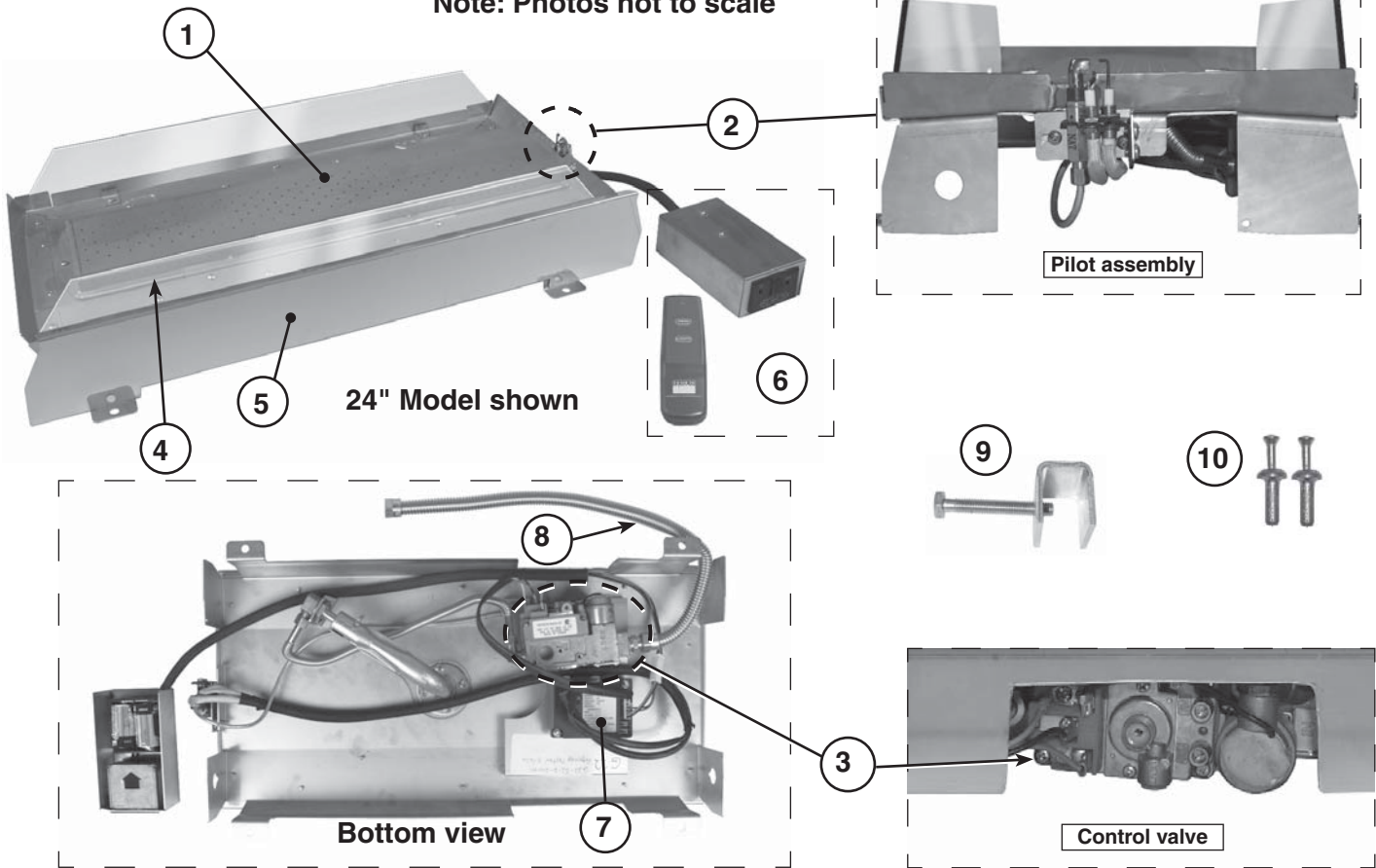

Fig. 6-2



BURNER PARTS LIST - REMOTE MODEL

Note: Photos not to scale



Replacement parts can be ordered from your local Real-Fyre dealer.

Item	Description	18" model		24" model		30" model	
		Part No.	Qty.	Part No.	Qty.	Part No.	Qty.
1.	Burner assembly (w/ venturi tube)	G22-2-07-18	1	G22-2-07-24	1	G22-2-07-30	1
2.	Pilot assembly (natural) or Pilot assembly (propane)	PAC-6 PAC-7	1 1	PAC-6 PAC-7	1 1	PAC-6 PAC-7	1 1
3.	Control valve (natural) or Control valve (propane)	SV-32 SV-33	1 1	SV-32 SV-33	1 1	SV-32 SV-33	1 1
4.	Glass panel	G22-2-06-18	2	G22-2-06-24	2	G22-2-06-30	2
5.	Reflective front cover (removable, shown installed) or Rose gold reflective front cover	G22-03-18 G22-03G-18	2 2	G22-03-24 G22-03G-24	2 2	G22-03-30 G22-03G-30	2 2
6.	Remote receiver box (includes transmitter)	RR-1A-SP	1	RR-1A-SP	1	RR-1A-SP	1
7.	Control module	IMP-1	1	IMP-1	1	IMP-1	1
8.	24" flex connector (w/ adapter)	3035	1	3035	1	3035	1
9.	Damper clamp	DC-1	1	DC-1	1	DC-1	1
10.	Hammer screws (pair)	G21-05	1	G21-05	1	G21-05	1

Glass/gems are purchased & packaged separately. Amount varies depending on model size;

18"	12.5 lbs [(1) 5 lb bag & (1) 7.5 lb bag]
24"	17.5 lbs [(1) 10 lb bag & (1) 7.5 lb bag]
30"	20.0 lbs [(2) 10 lb bags]

Glass/gems are available in 5, 7.5, or 10 lb bags, in various colors; contact your dealer for further details.

BURNER PARTS LIST - MANUAL MODEL

Note: Photos not to scale

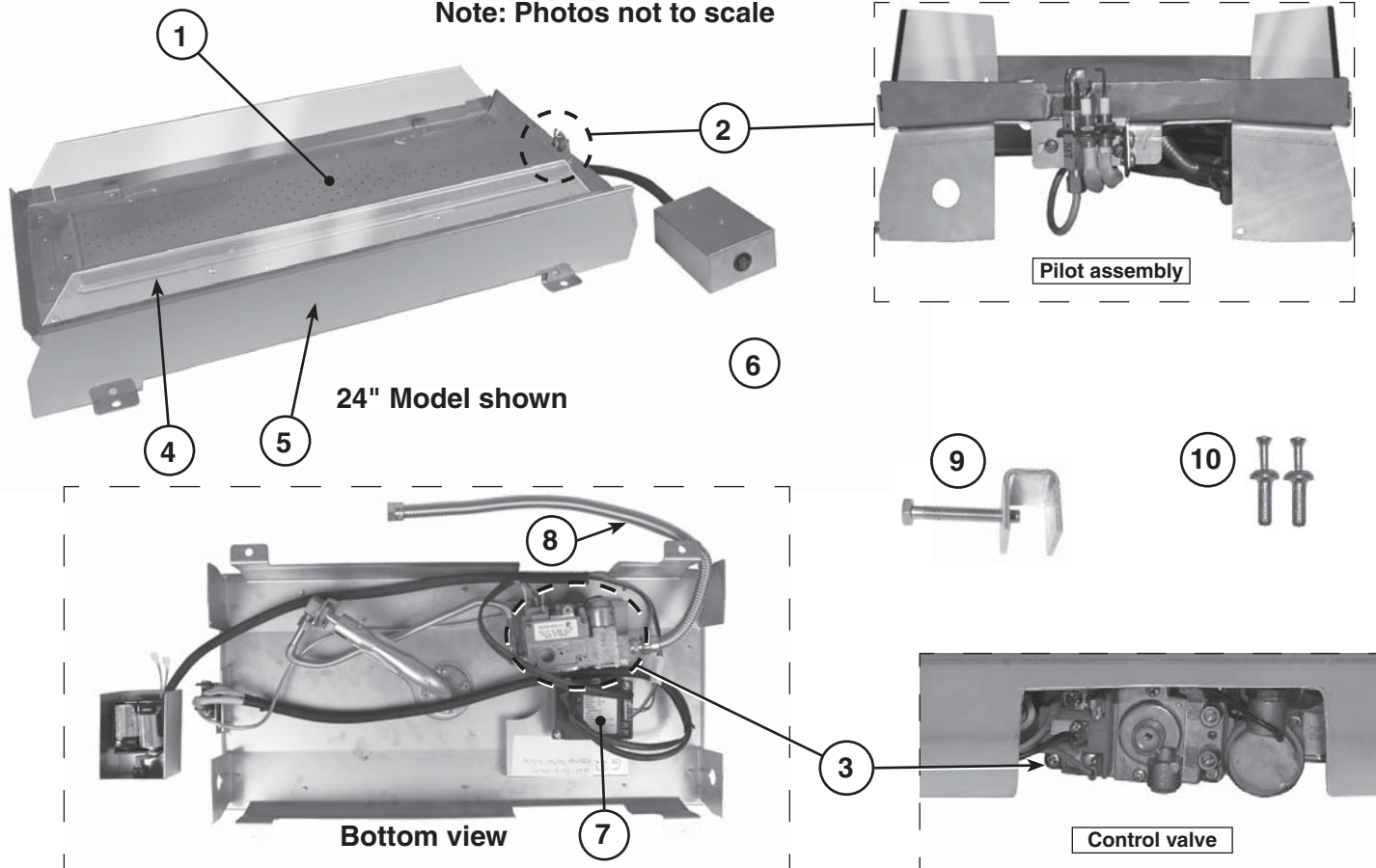

Replacement parts can be ordered from your local Real-Fyre dealer.

Item	Description	18" model		24" model		30" model	
		Part No.	Qty.	Part No.	Qty.	Part No.	Qty.
1.	Burner assembly (w/ venturi tube)	G22-2-07-18	1	G22-2-07-24	1	G22-2-07-30	1
2.	Pilot assembly (natural) or Pilot assembly (propane)	PAC-6 PAC-7	1 1	PAC-6 PAC-7	1 1	PAC-6 PAC-7	1 1
3.	Control valve (natural) or Control valve (propane)	SV-32 SV-33	1 1	SV-32 SV-33	1 1	SV-32 SV-33	1 1
4.	Glass panel	G22-2-06-18	2	G22-2-06-24	2	G22-2-06-30	2
5.	Reflective front cover (removable, shown installed) or Rose gold reflective front cover	G22-03-18 G22-03G-18	2 2	G22-03-24 G22-03G-24	2 2	G22-03-30 G22-03G-30	2 2
6.	Switch box	SW-11	1	SW-11	1	SW-11	1
7.	Control module	IMP-1	1	IMP-1	1	IMP-1	1
8.	24" flex connector (w/ adapter)	3035	1	3035	1	3035	1
9.	Damper clamp	DC-1	1	DC-1	1	DC-1	1
10.	Hammer screws (pair)	G21-05	1	G21-05	1	G21-05	1

Glass/gems are purchased & packaged separately. Amount varies depending on model size;

18"	12.5 lbs [(1) 5 lb bag & (1) 7.5 lb bag]
24"	17.5 lbs [(1) 10 lb bag & (1) 7.5 lb bag]
30"	20.0 lbs [(2) 10 lb bags]

Glass/gems are available in 5, 7.5, or 10 lb bags, in various colors; contact your dealer for further details.

BURNER INSTALLATION

The Real-Fyre burner system must be installed by a qualified professional service technician. Instructions must be followed carefully to ensure proper performance and full benefit from the burner system. **Check to be sure the burner system is designed and labeled for the type of gas (natural or propane gas) supplied to the fireplace. Fireplace floor must be level, clean, and smooth.**

WARNING: Failure to position the parts in accordance with these diagrams or failure to use only parts specifically approved with this appliance may result in property damage or personal injury.

Important: When the burner system is installed outdoors, ensure it is not directly exposed to the elements (precipitation, rain, wind, etc.).

REFER TO THE BURNER PARTS LIST WHEN FOLLOWING THESE INSTRUCTIONS.

1. MAKE SURE THE FIREPLACE GAS SUPPLY IS TURNED OFF.
2. Locate the gas-supply stub inside the fireplace and remove the cap, if attached (reference Fig. 9-1).

CAUTION: When removing the cap, make sure the stub does not turn, loosening the connection inside the wall.

3. Place the burner system in the fireplace. Center the burner in the fireplace. (Reference Fig. 9-2 for orientation.)
4. **Be sure gas to the fireplace is off.** Remove the adapter that is loosely connected to the flex connector (coming off of the burner system). Attach the adapter to the gas-supply stub using a pipe compound resistant to all gasses. Tighten securely. Then attach the open end of the flex connector to the adapter. Tighten securely (See Fig. 9-1).
5. **LEAK TEST:** Turn on the fireplace gas supply, and test at all connections for leaks using the appropriate soapy water solution. If bubbles appear, a leak is present. Turn off the gas and tighten at all connections. Repeat until no leaks are present. If a leak persists, turn off the gas supply and contact the local gas company or dealer. **NEVER USE A FLAME TO CHECK FOR LEAKS.**
6. Place the (switch/remote receiver) box at the right (or left) front corner of the fireplace. Be sure to run its wire through the opening on the right (or left) side of the burner system, and that the wire remains away from the burner system and its flame during operation (See Fig. 9-2, right side placement shown).
7. The burner system must be secured to the fireplace floor. The unit has anchoring tabs located on the bottom ends. With the unit centered, mark and then drill two 1/4" pilot holes, one on each side of the burner, on opposite ends.
8. Reposition the burner over the pilot holes and insert the provided hammer screws. Carefully hammer the screws in as shown in Fig. 9-3.
9. Use a power drill to complete the fastening of the screws (Fig. 9-4).

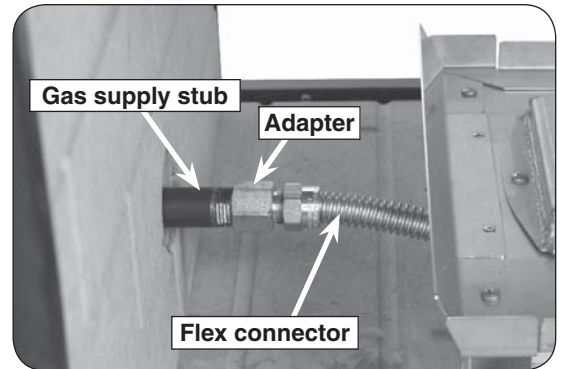

Fig. 9-1 Connect gas supply

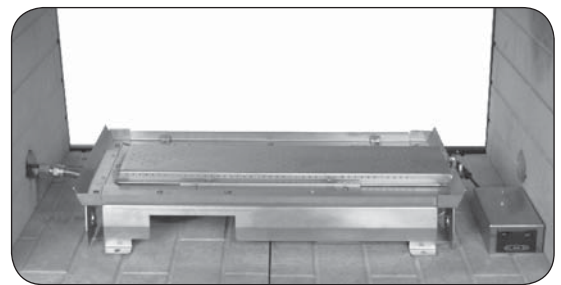

Fig. 9-2 Box location, right or left side

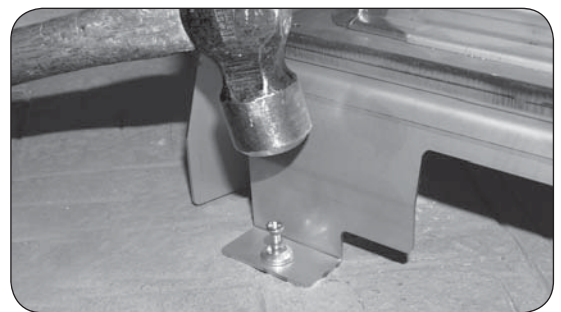

Fig. 9-3 Installing hammer screws



Fig. 9-4 Fastening hammer screws

BURNER INSTALLATION (cont.)

Note: Should the burner need to be removed for **servicing**; first unfasten the screw, then use a flat head screwdriver to pry up the anchoring tab until the wedge anchor pops out. See Fig. 10-1. The screw assembly is reusable.

10. Each side of the burner has tabs designed to hold the glass panels in place. First loosen the screws on the tabs with a screwdriver. Then position a glass panel in place, secure the tabs up against the panel, and fasten the screws. Repeat for the opposite side. Reference Fig. 10-2 and Fig. 10-3.

11. Remove the protective coating off of the reflective front covers. **DO NOT** use a sharp object to remove coating. Install the covers onto each side of the burner system (see Fig. 10-4).

Turn off the gas supply prior to proceeding.

REMOTE SYSTEM (if equipped)

For remote models; the remote system is already installed. Simply attach the included adapter switch to the front of the remote receiver (see Fig. 10-5). Read the separate remote instructions to familiarize yourself with the remote system.

For manual models; if a remote system is purchased later, read and follow the separate remote instructions (packed with remote) for complete remote installation.

IMPORTANT

For all valves, the air **MUST** be purged from the gas line before the pilot will light and burn properly. The time needed to purge will depend on the length of the gas line to the unit and the amount of time since the unit or gas line was last used. It may take several minutes before all the air is purged and the pilot will light and burn properly. Reference the LIGHTING INSTRUCTIONS section in this manual.

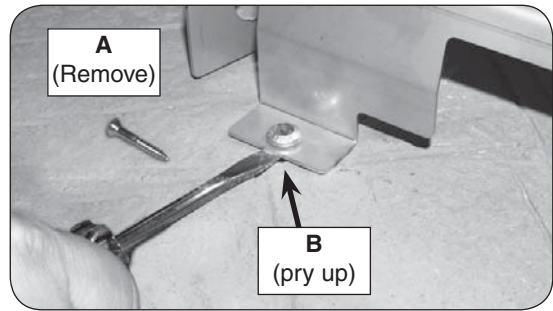

Fig. 10-1 If removal is required

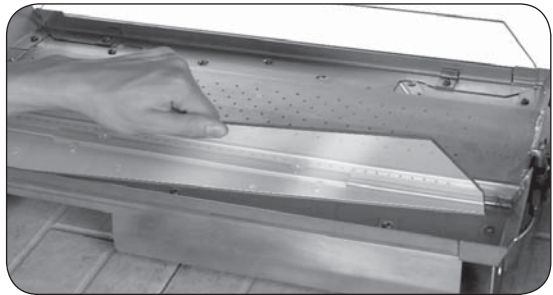

Fig. 10-2 Glass panel positioning



Fig. 10-3 Securing glass panel

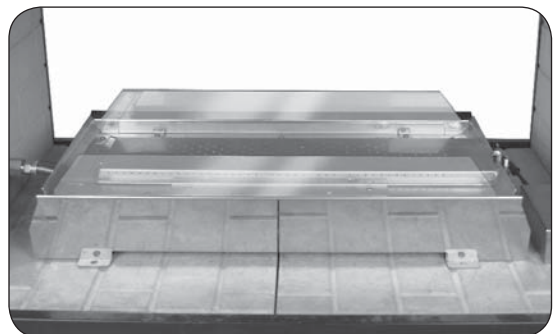

Fig. 10-4 Front cover installed

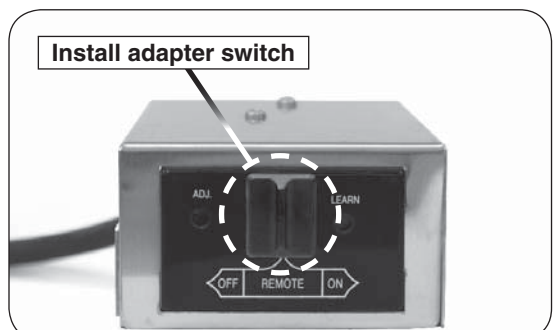

Fig. 10-5 Install switch (if applicable)

DECORATIVE MEDIA PLACEMENT

GLASS/GEMS PLACEMENT (purchased separately)

CAUTION: Glass pieces may have sharp edges. Be careful handling the glass. Use hand protection, such as gloves, if necessary.

Glass/gems (purchased separately) must be installed on the burner for the system to operate properly. See the table below for correct amounts of media for each model. Glass/gems are available in various colors; contact your dealer for further details.

Pour the glass/gems directly on top of the burner so that the burner pan is covered completely and evenly (see Fig. 11-1).

Model Size	Correct Amount of Fyre Glass/Gems to Use
18"	12.5 lbs
24"	17.5 lbs
30"	20.0 lbs

Important: When installing glass on your burner; DO NOT use the fine glass particles that have settled at the bottom of the glass bag. These particles will adversely affect the flame pattern.

Important: Do not add any additional glass/gems to this burner system. Any additional glass/gems may cause unsafe operation.

WARNING: All previously applied loose material must be removed prior to reapplication. All replacement loose material must be purchased from the R.H. Peterson Co.

DECORATIVE MEDIA ON FIREPLACE FLOOR (optional)

Glass, gems, or Lava-Fyre Granules may be placed on the fireplace floor as an enhancement to the burner system.

If purchased; spread the decorative media on the floor of the fireplace, around all sides of the burner system. See Fig. 11-2 for an example (reflective black glass shown). The media may be placed around and on top of the (switch / remote receiver) box. Leave the front of the box clear for control access.

CAUTION: DO NOT place any of this additional media into or onto the burner system, or behind it.

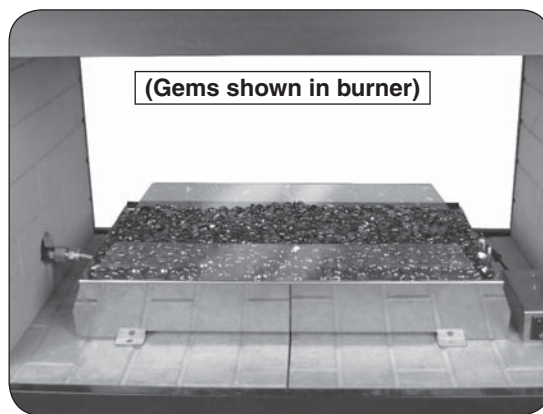

Fig. 11-1 Glass/gems placement

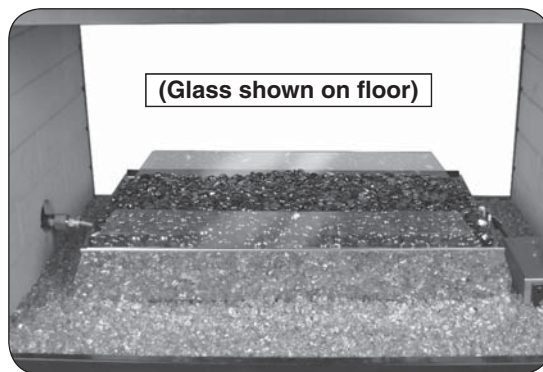

Fig. 11-2 Decorative media floor placement

CAUTION: BURN HAZARD. GLASS AND/OR GEMS ON BURNER SYSTEM WILL REMAIN HOT FOR SOMETIME AFTER USE. You must maintain the placement as shown to ensure proper operation of the burner system. If you need to reposition any media to maintain the proper layout, use heat-resistant gloves or allow media adequate time to cool before handling.

INSTALLING/REPLACING BATTERIES

CAUTION: ENSURE THE UNIT IS CONNECTED TO THE GAS LINE AND HAS BEEN TESTED FOR LEAKS BEFORE YOU INSERT BATTERIES.

REMOTE TRANSMITTER BATTERY (remote models only)

To access the battery, slide open the lid found on the back of the remote transmitter. Replace the old battery with a new "12v" battery. Re-secure the lid.

REMOTE RECEIVER BATTERIES AND/OR REMOTE RECEIVER BOX BATTERIES (remote models only)

To access the batteries, locate the remote receiver box and turn it over. The exposed "D" battery pack is for electronic ignition. Replace the old batteries with (2) new "D" batteries. (See Fig. 12-1.)

Slide open the lid on the remote receiver to expose the batteries. Replace the old batteries with (4) new "AA" batteries. (See Fig. 12-1.) Replace the lid.

SWITCH BOX BATTERIES (remote models only)

To access the batteries, locate the switch box and turn it over. The exposed "D" battery pack is for electronic ignition. Replace the old batteries with (2) new "D" batteries. (See Fig. 12-2.)

When battery replacement is complete; properly place the (switch / remote receiver) box in the fireplace as instructed in the BURNER INSTALLATION section of this manual.

Important: Low/dead batteries will affect burner system operation. Replace batteries any time the burner will not turn on.

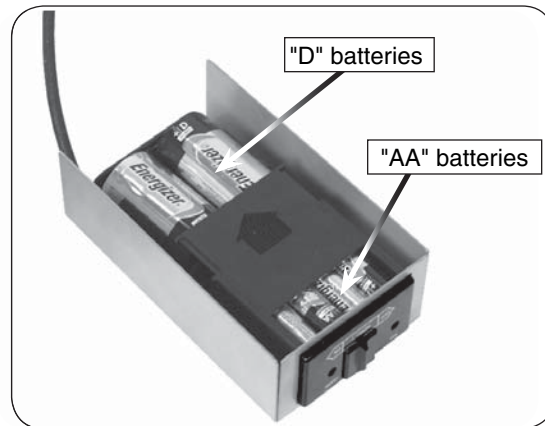

Fig. 12-1 Remote receiver box batteries

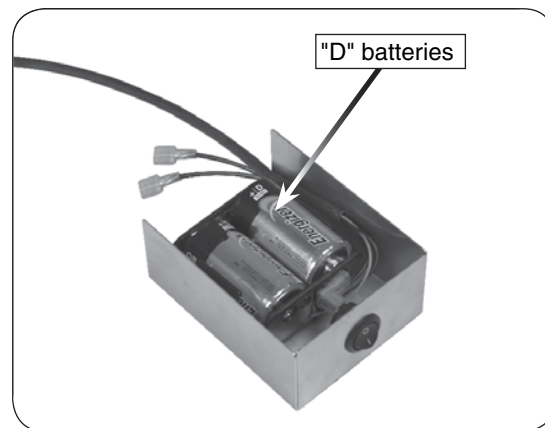

Fig. 12-2 Switch box batteries

FOR YOUR SAFETY, READ BEFORE LIGHTING

WARNING: If you do not follow these instructions exactly, a fire or explosion may result, causing property damage, personal injury, or loss of life.

Do not use this appliance if any part has been underwater. Immediately call for a qualified professional service technician to inspect the appliance and to replace any part of the control system and any gas control that has been underwater.

BEFORE LIGHTING, smell all around the burner area for gas. Be sure to smell next to the floor, as some gas is heavier than air and will settle on the floor. IF YOU SMELL GAS, FOLLOW THE INSTRUCTIONS ON PG. 1.

MANUAL LIGHTING

1. Turn off any electrical appliance.
2. Press the remote receiver control to the **ON** position. This transmits a rapid series of sparks at the pilot head and will ignite the gas.

Sparks cease when the pilot flame is lit and stable. After a short time, the pilot will then light the main burner.

CAUTION: IF THE BURNER DOES NOT IGNITE WITHIN 20 SECONDS, TURN OFF, WAIT 5 MINUTES, THEN REPEAT STEPS 1. AND 2. ABOVE.

If the pilot will not stay lit after several tries, turn the receiver to **OFF** and contact a qualified professional service technician or gas supplier.

REMOTE LIGHTING

1. Turn off any electrical appliance.
2. Press the remote receiver control to the **REMOTE** position. Then press the **ON** button on the remote transmitter. This transmits a rapid series of sparks at the pilot head and will ignite the gas.

Sparks cease when the pilot flame is lit and stable. after a short time, the pilot will then light the main burner.

CAUTION: IF THE BURNER DOES NOT IGNITE WITHIN 20 SECONDS, TURN OFF, WAIT 5 MINUTES, THEN REPEAT STEPS 1. AND 2. ABOVE.

If the pilot will not stay lit after several tries, turn the receiver to **OFF** and contact a qualified professional service technician or gas supplier.

In addition to these instructions; reference the separate remote instructions for further details on the remote system.

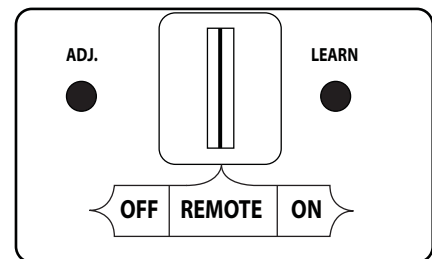

Fig. 13-1 Remote receiver

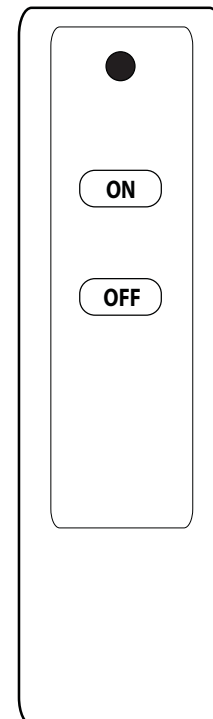

Fig. 13-2 Remote transmitter

POUR VOTRE SÛRETÉ, LISEZ AVANT L'ALLUMAGE

AVERTISSEMENT: Si vous ne suivez pas ces instructions exactement, une incendie ou une explosion peut résulter, entraînant des dégâts matériels, le dommage corporel, ou des pertes humaines.

N'employez pas cet appareil si n'importe quelle partie a été sous-marine. Réclamez immédiatement un technicien qualifié de service professionnel pour inspecter l'appareil et pour remplacer n'importe quelle partie du système de contrôle et de n'importe quelle commande de gaz qui a été sous-marine.

AVANT L'ALLUMAGE, sentez tous autour du secteur de brûleur pour le gaz. Soyez sûr de sentir à côté du plancher, car un certain gaz est plus lourd que l'air et arrangerà sur le plancher. SI VOUS SENTEZ LE GAZ, SUIVEZ LES INSTRUCTIONS À LA PAGE. 1.

ÉCLAIRAGE MANUEL

1. Arrêtez n'importe quel appareil électrique.
2. Pressez la commande à distance de récepteur à la position de fonctionnement. Ceci transmet une série rapide d'étincelles à la tête pilote et mettra à feu le gaz.

Les étincelles cessent quand la flamme pilote est allumée et écurie. Après une brève durée, le pilote allumera alors le brûleur principal.

ATTENTION: SI LE BRÛLEUR NE MET PAS À FEU DANS 20 SECONDES, ÉTEIGNEZ, ATTENDEZ 5 MINUTES, ALORS RÉPÉTEZ LES ÉTAPES 1. ET 2. CI-DESSUS.

Si le pilote ne restera pas allumé après que plusieurs essais, tournent le récepteur à AU LOIN et contactent un fournisseur qualifié de technicien ou de gaz de service professionnel.

ÉCLAIRAGE À DISTANCE

1. Arrêtez n'importe quel appareil électrique.
2. Pressez la commande de boîte de commutateur dans la position À DISTANCE. Appuyez sur alors DESSUS le bouton sur l'émetteur à distance. Ceci transmet une série rapide d'étincelles à la tête pilote et mettra à feu le gaz.

Les étincelles cessent quand la flamme pilote est allumée et écurie. Après une brève durée, le pilote allumera alors le brûleur principal.

ATTENTION: SI LE BRÛLEUR NE MET PAS À FEU DANS 20 SECONDES, ÉTEIGNEZ, ATTENDEZ 5 MINUTES, ALORS RÉPÉTEZ LES ÉTAPES 1. ET 2. CI-DESSUS.

Si le pilote ne restera pas allumé après que plusieurs essais, tournent le récepteur à AU LOIN et contactent un fournisseur qualifié de technicien ou de gaz de service professionnel.

En plus de ces instructions; mettez en référence les instructions à distance séparées pour d'autres détails sur le système à distance.

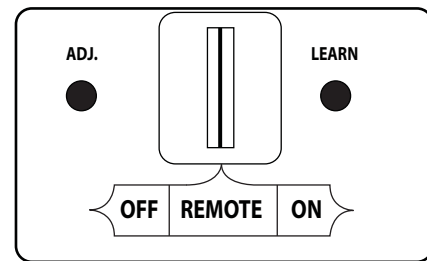

Fig. 14-1 Récepteur à distance

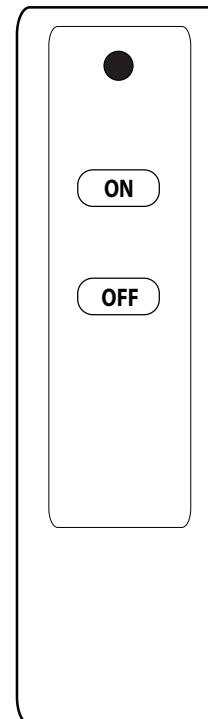

Fig. 14-2 Émetteur à distance

PILOT APPEARANCE

Periodically check the pilot for proper flame pattern. The pilot flame should encircle the generator tip, and is preset at the factory (see Fig. 15-1).

If the pilot flame burns incorrectly; shut down completely and contact a qualified professional service technician.

SHUTTING DOWN

1. Simply press the receiver control to the **OFF** position when manually operated. The gas flow will cease, and all the flames (main burner and pilot) will go out.
2. For remote operation, press the **OFF** button on the transmitter.

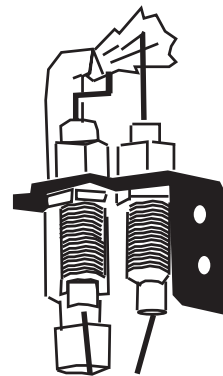

Fig. 15-1 Proper pilot flame

ASPECT PILOTE

Examinez périodiquement le pilote pour assurer le modèle approprié de flamme. La flamme pilote devrait encercler le bout de générateur, et est préréglée à l'usine (voir la Fig. 16-1).

Si la flamme pilote brûle inexactement; arrêtez complètement et contactez un technicien qualifié de service professionnel.

ARRÊT

1. Pressez simplement la commande de récepteur à la position de repos si manuel. L'écoulement de gaz cessera, et toutes les flammes (brûleur et pilote principaux) sortiront.
2. Pour l'opération à distance, appuyez sur AU LOIN le bouton sur l'émetteur.

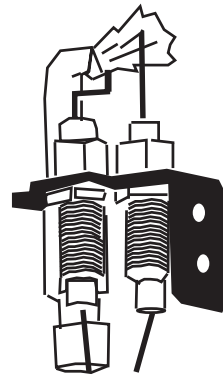

Fig. 16-1 Flamme pilote appropriée

FOR YOUR SAFETY, READ BEFORE LIGHTING

WARNING: If you do not follow these instructions exactly, a fire or explosion may result, causing property damage, personal injury, or loss of life.

Do not use this appliance if any part has been underwater. Immediately call for a qualified professional service technician to inspect the appliance and to replace any part of the control system and any gas control that has been underwater.

BEFORE LIGHTING, smell all around the burner area for gas. Be sure to smell next to the floor, as some gas is heavier than air and will settle on the floor. IF YOU SMELL GAS, FOLLOW THE INSTRUCTIONS ON PG. 1.

1. Turn off any electrical appliance.
2. Press the "I" (Ignite) switch on the front of the switch box. This transmits a rapid series of sparks at the pilot head and will ignite the gas.

Sparks cease when the pilot flame is lit and stable. After a short time, the pilot will then light the main burner.

CAUTION: IF THE BURNER DOES NOT IGNITE WITHIN 20 SECONDS, TURN OFF, WAIT 5 MINUTES, THEN REPEAT STEPS 1. AND 2. ABOVE.

If the pilot will not stay lit after several tries, turn the switch box to "O" (OFF) and contact a qualified professional service technician or gas supplier.

PILOT APPEARANCE

Periodically check the pilot for proper flame pattern. The pilot flame should encircle the generator tip, and is preset at the factory (see Fig. 17-2).

If the pilot flame burns incorrectly; shut down completely and contact a qualified professional service technician.

SHUTTING DOWN

1. Simply press the "O" (OFF) switch on the front of the switch box. The gas flow will cease, and all the flames (main burner and pilot) will go out.

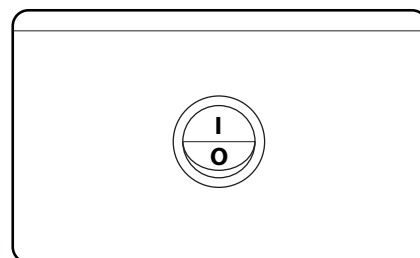

Fig. 17-1 ON/OFF switch

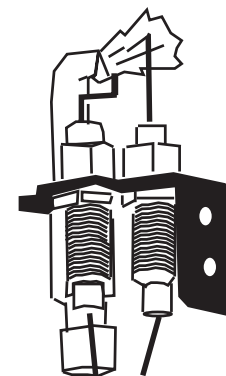

Fig. 17-2 Proper pilot flame

POUR VOTRE SÛRETÉ, LISEZ AVANT L'ALLUMAGE

AVERTISSEMENT: Si vous ne suivez pas ces instructions exactement, une incendie ou une explosion peut résulter, entraînant des dégâts matériels, le dommage corporel, ou des pertes humaines.

N'employez pas cet appareil si n'importe quelle partie a été sous-marine. Réclamez immédiatement un technicien qualifié de service professionnel pour inspecter l'appareil et pour remplacer n'importe quelle partie du système de contrôle et de n'importe quelle commande de gaz qui a été sous-marine.

AVANT L'ALLUMAGE, sentez tous autour du secteur de brûleur pour le gaz. Soyez sûr de sentir à côté du plancher, car un certain gaz est plus lourd que l'air et arrangera sur le plancher. SI VOUS SENTEZ LE GAZ, SUIVEZ LES INSTRUCTIONS À LA PAGE. 1.

1. Arrêtez n'importe quel appareil électrique.
2. Pressez le "I" (Mettez à feu) branchez l'avant de la boîte de commutateur. Ceci transmet une série rapide d'étincelles à la tête pilote et mettra à feu le gaz.

Les étincelles cessent quand la flamme pilote est allumée et écurie. Après une brève durée, le pilote allumera alors le brûleur principal.

ATTENTION: SILE BRÛLEUR NE MET PAS À FEU DANS 20 SECONDES, ÉTEIGNEZ, ATTENDEZ 5 MINUTES, ALORS RÉPÉTEZ LES ÉTAPES 1. ET 2. CI-DESSUS.

Si le pilote ne restera pas allumé après que plusieurs essais, tournent la boîte de commutateur au "O" (AU LOIN) et contactez un fournisseur qualifié de technicien ou de gaz de service professionnel.

ASPECT PILOTE

Examinez périodiquement le pilote pour assurer le modèle approprié de flamme. La flamme pilote devrait encercler le bout de générateur, et est préréglée à l'usine (voir la Fig. 18-2).

Si la flamme pilote brûle inexactement ; arrêtez complètement et contactez un technicien qualifié de service professionnel.

ARRÊT

1. Pressez simplement le "O" (AU LOIN) branchez l'avant de la boîte de commutateur. L'écoulement de gaz cessera, et toutes les flammes (brûleur et pilote principaux) sortiront.

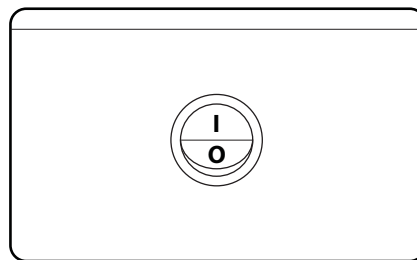

Fig. 18-1 Commutateur "MARCHE/ARRÊT"

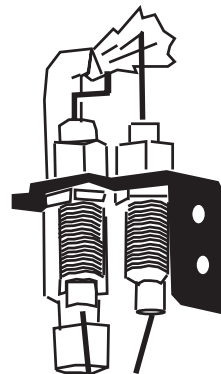

Fig. 18-2 Flamme pilote appropriée

CLEANING AND SERVICING SAFETY INFORMATION

Note: Regular cleaning and servicing will be necessary to ensure proper pilot operation and proper burn characteristics.

Always shut off the gas to the appliance while performing service work.

Allow the appliance to cool before servicing.

Installation, service, and repair must be done by an NFI Certified or other qualified professional service technician. The appliance MUST be inspected before use, and cleaned at least annually to prevent burner shutdown, sooting, odors, etc. by a qualified professional service technician. It must be checked for clean burning operation and proper pilot appearance, with the correct tools to service this unit. More frequent cleaning may be required. Excessive lint can build up on this unit from carpeting, bedding material, pet hairs, or other particles in the air. It is imperative that all control components and compartments, burner(s), air shutters, and circulating air passageways of the appliance be kept clean and free of all obstructions.

In addition, a periodic examination and cleaning of the solid-fuel-burning fireplace venting system should be conducted by a qualified professional service technician.

Any safety screen or guard removed for servicing must be replaced prior to operating this appliance.

TO CLEAN THE BURNER SYSTEM

1. Remove the glass/gems. Use a vacuum cleaner to remove loose particles from all surfaces of the burner system. Do not use cleaning fluids.
2. Dust the assembly and the burner. Using a compressed air duster (commonly available at computer, electronic, or office supply stores); blow through all of the burner ports, and the pilot assembly area.
3. Replace batteries as needed.
4. Reinstall the glass/gems as instructed in this manual.

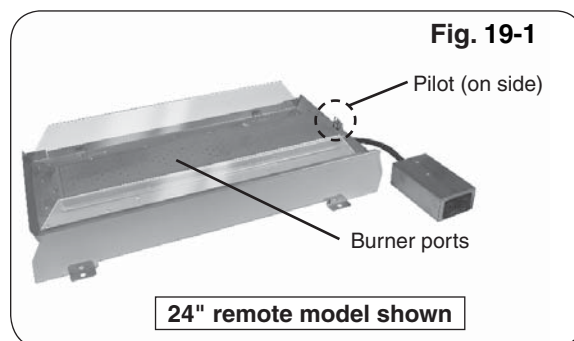

If, after a period of use, the flames start to exhibit unusual shapes and behavior, or the burners fail to ignite smoothly, the burner ports may require some cleaning. If this happens, it is preferable to contact the nearest dealer to get the appliance serviced.

Do not remove the rating plates or the warning tags. These are an integral safety and identification component of this appliance.

We recommend following these instructions at the beginning of each fireplace season and as needed throughout the year, depending on your usage pattern and the environmental conditions in your home. More frequent cleaning and maintenance may be necessary when burning propane gas than with natural gas.

FLAME DESCRIPTION

Observe the flames. The main burner flames should be blue at the base and a combination of blue/yellow at the body and at the tips. They should be approximately 8" above the glass/gems, with the center flame being the tallest. (See cover photo for example.)

NOTES PAGE

Please use this page to record any information that you may want to have at hand.

TROUBLESHOOTING

POSSIBLE CAUSE	SOLUTIONS
----------------	-----------

1 BURNER SHUTTING DOWN DURING OPERATION

A. Insufficient or excessive gas pressure	A1. Check gas pressure (Read G.- I. of IMPORTANT PRE-INSTALLATION AND FIREPLACE SAFETY INFORMATION section, & <u>check with local gas company</u>). A2. Other gas appliances may be on the same gas line, dropping gas pressure to log set. Check pressures with everything operating to ensure adequate pressure.
B. Flue area, fireplace, or damper dirty from soot	B. Clean around, above, and under damper thoroughly. Clean fireplace, removing loose material, including soot and creosote.
C. Fireplace too small for unit	C. Ensure minimum requirements are met. (See FIREPLACE SIZE REQUIREMENT section in this owner's manual.)
D. Pilot flame lifting off thermocouple/generator	D. Check gas pressure (see section A1).
E. Pilot (remote compatible)	E. Contact your dealer for instructions on replacement.
F. Blockages on burner	F. Vacuum any lava granules or material that may have fallen onto burner port area.

2 PILOT WILL NOT LIGHT

A. Pilot flame lifting off thermocouple/generator	A. Check gas pressure (see Section 1, A1 of this table).
B. Electronic spark not lighting pilot	B. Check to ensure sparking when activated.
C. Ignitor electrode wire loose	C. Check wiring and reconnect any loose wiring.
D. Gas supply off/manual shutoff valve closed	D. Turn on gas supply or open manual shutoff valve.
E. Air in gas line	E. Bleed the gas supply line and repeat LIGHTING INSTRUCTIONS until air is removed.
F. Pilot hood blocked	F. Check for debris or dirt / clean pilot

3 LOW FLAME HEIGHT

A. Gas pressure	A. Check gas pressure (see Section 1, A1 of this table).
B. Propane tank running low	B. Fill tank completely.

4 BURNER NOT BURNING EVENLY

A. Burner orifice clogged	A. Clean burner orifice.
----------------------------------	---------------------------------

5 ODORS

A. Gas leak	A. Shut off gas, if possible. Follow instructions on front page. Have a qualified professional installer or the gas company correct all leaks.
B. New home, new carpet, or new paint	B. When these odors are drawn into the fireplace, this may cause objectionable odors. Thoroughly ventilate the area before restarting your burner system.

TROUBLESHOOTING (Cont.)

POSSIBLE CAUSE	SOLUTIONS
6 SOOTING	
A. Low gas pressure	A. Check gas pressure (see Section 1, A1 of this table).
B. Drafts in room	B. Eliminate drafts by closing heating and air conditioning vents, returns, and outside air vents. Fans blowing directly into fireplace should be turned off when set is operating.
C. Air shutters blocked (if applicable)	C. Air shutters are blocked with debris. Vacuum debris away from air shutter.
D. Using a product other than Real-Fyre® glass/gems with burner	D. Make sure only Real-Fyre® glass/gems are used with your vent-free burner.
E. Using natural-gas burner on propane gas or propane burner on natural gas	E. If the gas listed on the nameplate does not match the gas you are burning, shut down the burner system immediately and completely (including pilot) following the steps in the LIGHTING INSTRUCTIONS section. Then call your dealer.
F. Adding any accessories to burner system	F. Shut down log set and take off any accessories that do not belong with the system.
7 PILOT WILL NOT STAY LIT	
A. Valve won't hold	A. Contact your dealer for instructions on replacement.
B. Pilot hood not aimed at thermocouple	B. Pilot hood bent; replace pilot or angle pilot hood properly so pilot flame hits thermocouple.
C. Pilot line bent	C. Replace pilot line.
D. Thermocouple is loose	D. Tighten thermocouple nut at gas control valve.
E. Thermocouple cracked or worn out	E. Replace thermocouple.
F. Excessive down draft	F. Install chimney cap / Outside chimney too close to other peaks / Check chimney flue for proper height / Poorly designed chimney
8 BURNER WILL NOT TURN ON	
A. Low/dead batteries in remote transmitter (if applicable) AND/OR (switch/receiver) box	A. Replace batteries as needed.

Detail A

Electrode (A)

When adjusting the spark electrode (if necessary); NEVER adjust the electrode by bending the wire. ALWAYS adjust the electrode by loosening the retainer nut(s), then adjust accordingly.

The minimum gap between the spark electrode/sensor electrode and the pilot flame hood is 1/8". The maximum is 5/32".

If the electrode ceramic is loose in the threaded barrel; the pilot assembly must be replaced.

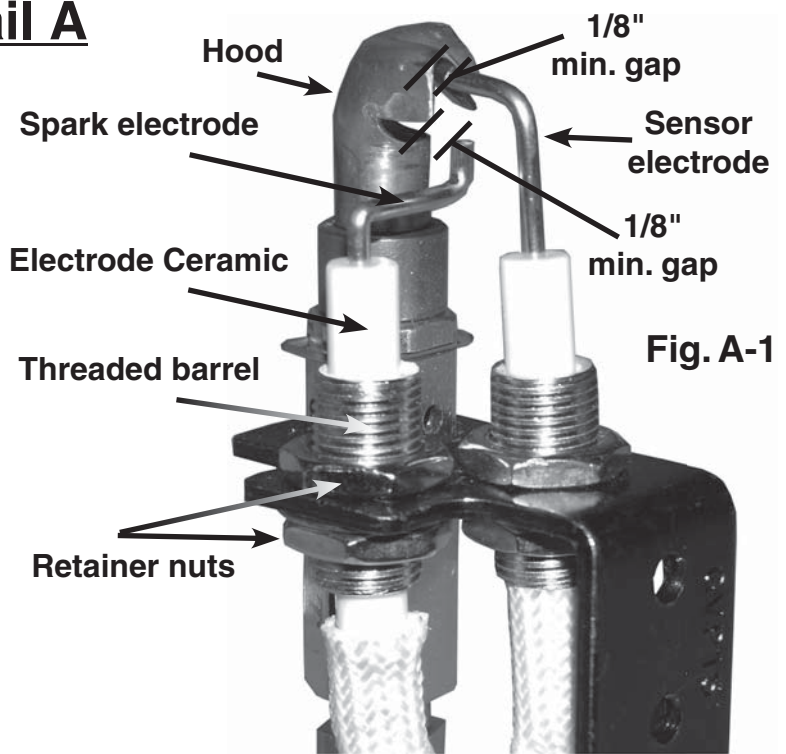

Fig. A-1

Detail B

Terminal Connections (B)

All of the connections on the control module must be properly attached. If the spade terminals are loose; inspect to ensure they correctly appear as detailed below. Use needle nose pliers to clamp down on the center/sides of the terminals if needed (to provide a tight fit.)

Spade Terminal Detail



Ensure that spade terminals (S and I) are attached securely

Ensure that multi-wire connector is properly locked in place

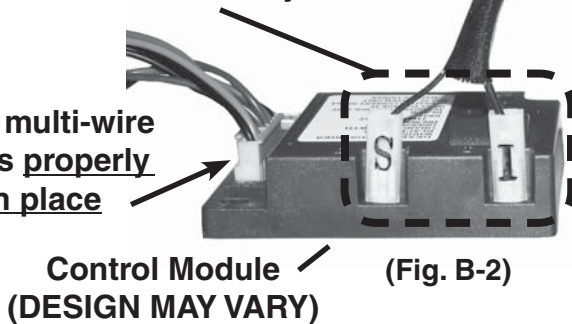

Tighten terminals if needed

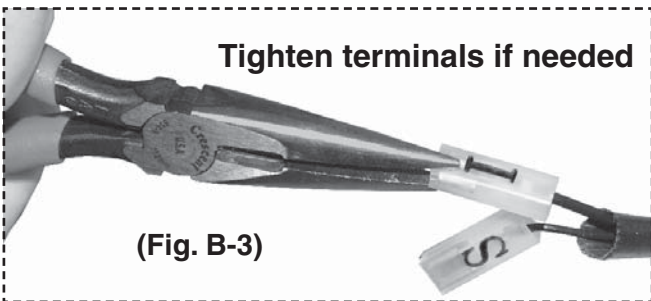

Detail C

(Fig. C-1)

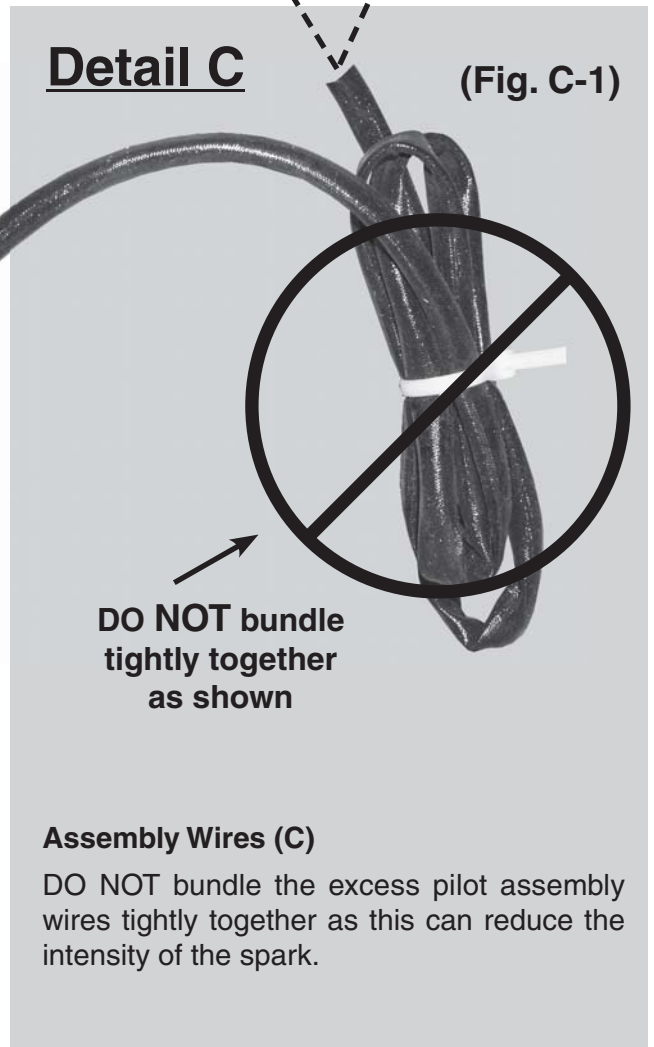

Assembly Wires (C)

DO NOT bundle the excess pilot assembly wires tightly together as this can reduce the intensity of the spark.

WARRANTY

PETERSON VENTED DECORATIVE GAS APPLIANCE LIMITED WARRANTY

Robert H. Peterson Co. ("RHP") warrants your Real Fyre® vented decorative gas appliance to be free from defects in material and workmanship.

Peterson vented ceramic refractory gas logs are warranted for **as long as you own them (lifetime)**.

Peterson vented burner assemblies are **WARRANTED for TEN (10) YEARS**. Peterson vented outdoor stainless-steel burner assemblies are warranted for **FIVE (5) YEARS**.

Peterson glass, gems, nuggets, and fiber-ceramic blend gas logs are warranted for **FIVE (5) YEARS**.

SPK-26 controls are warranted for **THREE (3) YEARS**.

APK-17 controls (including -17 valve) are warranted for **TWO (2) YEARS**.

All other Peterson valves, pilots, and controls are warranted for **ONE (1) YEAR (excluding batteries)**.

A COPY OF YOUR SALES SLIP FOR PROOF OF PURCHASE IS REQUIRED

This warranty applies to the original purchaser for products which are installed in the United States or Canada and which are operated and maintained as intended for single family residential usage. This warranty is valid only with proof of purchase, shall commence on the date of purchase, and shall terminate (both as to original and any replacement products) on the anniversary date of the original purchase of the product stated on the above schedules.

This warranty covers defects in material and workmanship. This warranty **does not** cover parts which become defective as a result of negligence, misuse, use not in compliance with the Owner's Manual/Installation Instructions, accidental damage, improper handling, improper storage, improper installation, lack of required routine maintenance (as specified in the Owner's Manual/Installation Instructions), electrical damage, local gas impurities or failure to protect against combustibles. Product must be installed (and gas must be connected) as specified in the Owner's Manual/Installation Instructions by a **qualified professional installer**. Modifications to products which are not specifically authorized will void this warranty. Accessories, parts, valves, remotes, etc. when used must be Peterson products or this warranty is void. Warranted items will be repaired or replaced at Peterson's sole discretion. This warranty **does not** apply to rust, corrosion, oxidation, or discoloration unless the affected part becomes inoperable.

This warranty **does not** cover labor or labor related charges, except as provided by separate specific written programs from the Peterson Co. All repair work must be performed by a qualified professional service person and requires prior approval of Peterson.

Peterson may require the defective product or part to be returned to the factory to determine the cause of failure. Peterson will pay freight charges if the product or part is determined to be defective. This warranty does not cover breakage in shipment from our (Independent) distributor to its customer if the damage is determined to have occurred during that shipment.

This warranty specifically excludes liability for **indirect, incidental, or consequential** damages. Some states and provinces do not allow the exclusion or limitation of incidental or consequential damages, so the above exclusion may not apply to you. This warranty gives you specified legal rights, and you may have other rights that vary from state to state or province.

For additional information regarding this warranty, or to place a warranty claim, contact the R. H. Peterson dealer where the product was purchased.

**TO REGISTER YOUR PRODUCT ONLINE GO TO: WWW.RHPETERSON.COM,
AND CLICK ON PRODUCT REGISTRATION. THANK YOU FOR YOUR PURCHASE.**

FOR USE IN THE COMMONWEALTH OF MASSACHUSETTS

**INSTALLATION OF THIS APPLIANCE MUST BE PERFORMED BY A MASSACHUSETTS
LICENSED PLUMBER OR GAS FITTER ONLY.**

**CONNECTOR KITS USED FOR INSTALLATION AND OPERATION OF THIS APPLIANCE
MUST NOT BE MORE THAN 36" IN LENGTH.**

**FIREPLACE DAMPER MUST BE REMOVED OR PERMANENTLY FIXED/WELDED IN FULL
OPEN POSITION PRIOR TO INSTALLING THIS PRODUCT.**

Quality Check

Date: _____

Burner Orifices	Nat.	L.P.	Leak Test:	_____	Model#:	_____
Main:	_____	_____	Burn Test:	_____	Serial#:	_____
Other:	_____	_____	Gas Type:	Nat. / L.P.	Air Shutter:	_____
					Inspector:	_____