

**Burner Systems:
 G22-GL-(18, 24, 30)(G)**

Regulated burner system, for use with natural gas only

FOR USE WITH
 FYRE GLASS / FYRE GEMS

18"	10.0 lbs
24"	12.5 lbs
30"	15.0 lbs



DESIGN CERTIFIED
 to
 Manually Lighted, Natural Gas
 Vented Decorative Appliance
 ANSI Z21.84-2012

**FOR INSTALLATION IN
 SOLID-FUEL
 BURNING FIREPLACES***

**FOR INDOOR OR
 OUTDOOR USE**

G22-GL VENTED BURNER SYSTEMS (MANUALLY LIGHTED)

WARNING

If the information in this manual is not followed exactly, a fire or explosion may result, causing property damage, personal injury, or loss of life.

Do not store or use gasoline or other flammable vapors and liquids in the vicinity of this or any other appliance.

WHAT TO DO IF YOU SMELL GAS:

- Open a window.
- Do not try to light any appliance.
- Do not touch any electrical switch; do not use any phone in the building.
- Immediately call the gas supplier from a neighbor's phone. Follow gas supplier's instructions.
- If you cannot reach the gas supplier, call the fire department.

Installation and service must be performed by a qualified professional installer, service agency, or the gas supplier.

This appliance is only for use with the type of gas indicated on the rating plate.

IMPORTANT: READ THESE INSTRUCTIONS CAREFULLY BEFORE STARTING INSTALLATION OF THE UNIT.

The Real-Fyre burner system is to be installed only in a solid-fuel burning fireplace with a working flue and constructed of noncombustible material. The installation, including provisions for combustion and ventilation air must conform with the *National Fuel Gas Code, ANSI Z223.1/NFPA 54*, or the *CSA B149.1, Natural Gas and Propane Installation Code*, and applicable local building codes.

A damper clamp is included to maintain the minimum permanent vent opening and to prevent full closure of the damper blade. **The chimney damper MUST be fully opened when burning the unit. The unit is designed to burn with yellow flames; thus adequate ventilation is absolutely necessary.**

To comply with certification, listings, and building code acceptances, and for safe operation and proper performance of this burner system, use ONLY Peterson parts and accessories. Use of other controls, parts, and accessories that are not designed for use with Real-Fyre burner systems is prohibited and will void all warranties, certifications, listings, and building code approvals, and may cause property damage, personal injury, or loss of life.

***Note:** Solid-fuels shall not be burned in a fireplace where a decorative appliance is installed.



INSTALLER:
 Leave this manual with the appliance.
CONSUMER:
 Retain this manual for future reference.



12-021

TABLE OF CONTENTS

3	IMPORTANT PRE-INSTALLATION AND FIREPLACE SAFETY INFORMATION
4	SPECIFICATIONS
4	DAMPER CLAMP INSTRUCTIONS
5	BURNER PARTS LIST
6	BURNER INSTALLATION
8	DECORATIVE MEDIA PLACEMENT
8	GLASS/GEMS PLACEMENT (purchased separately)
8	DECORATIVE MEDIA ON FIREPLACE FLOOR (optional)
9	LIGHTING INSTRUCTIONS
9	SHUTTING DOWN
10	CLEANING AND SERVICING SAFETY INFORMATION
10	TO CLEAN THE BURNER SYSTEM
10	FLAME DESCRIPTION
11	TROUBLESHOOTING
12	WARRANTY

IMPORTANT PRE-INSTALLATION AND FIREPLACE SAFETY INFORMATION

CAUTION: Installation and repair must be done by an NFI Certified or other qualified professional installer.

Installer: Carefully read these instructions before installing this gas burner system. Be sure you understand all safety precautions and warnings contained in this manual.

- A. This appliance is designed as an **attended appliance**. Adults must be present when this gas appliance is operating. Do not leave this unit burning when unattended or while anyone is sleeping.
- B. This appliance is only for use with the type of gas indicated on the rating plate. This appliance is **NOT FIELD CONVERTIBLE** for use with other gasses.
- C. **BE CAREFUL: If not installed, serviced, and used correctly per these instructions, this product can cause serious personal injury, property damage, or loss of life.**
- D. **WARNING:** Before installing in a solid-fuel-burning fireplace, the chimney flue, damper, and firebox must be thoroughly CLEANED of soot, creosote, ashes, and loose paint, and must be inspected by a qualified chimney cleaner. Some older fireplaces may need repair prior to installing this appliance.
- E. CHECK GAS TYPE (natural): The gas supply must be the same as stated on your burner system rating plate. If gas supply is different, **DO NOT INSTALL**. Contact your dealer for immediate assistance.
- F. Keep the area of the gas burner system clear and free from combustible materials, gasoline, and other flammable vapors and liquids.
- G. INSUFFICIENT GAS PRESSURE WILL KEEP THE UNIT FROM OPERATING PROPERLY. DO NOT USE IF GAS PRESSURE IS LOWER THAN THE MINIMUM REQUIREMENT.
- H. The minimum inlet gas supply pressure for purposes of input adjustment is **5"** water column (w.c.) on **natural gas**. Insufficient gas pressure will affect proper operation of the pilot (if equipped). Do not install this gas appliance if minimum pressure is not available. The maximum inlet gas supply pressure is 10.5" w.c. on natural gas. (Do not connect this appliance directly to a natural gas tank-this can cause an explosion.)
- I. **The gas piping system must be sized to provide minimum inlet pressure at the maximum flow rate (BTU/hr).** Undue pressure loss will occur if the pipe is too small, or the run is too long. Gas supply pipe must be 1/2" minimum interior diameter. If the gas line is longer than 20', a larger diameter line may be necessary. Refer to the NFPA 54 guidelines for further details.
- J. Input ratings shown in BTU per hour are for elevations up to 2,000 ft. For elevations above 2,000 ft., refer to the National Fuel Gas Code or contact manufacturer before installing this product.
- K. This gas appliance and its main gas valve must be disconnected from the gas-supply piping system during any pressure testing of that system at test pressures in excess of 1/2 psig.
- L. This gas appliance must be isolated from the gas-supply piping system by closing the equipment shutoff valve connected to the gas-supply line during any pressure testing of the gas-supply piping system at test pressures equal to or less than 1/2 psig.
- M. Do not use this appliance if any part has been underwater. Immediately call a qualified service technician to inspect the appliance and to replace any part of the control system and any gas control that has been underwater.
- N. **A fireplace screen must be in place when the system is burning.** Provisions for adequate combustion air must be maintained. Unless other provisions for combustion air are provided, the screen shall have an opening(s) for introduction of combustion air. Combustion air is adequate when all flames curl into the fireplace and away from the screen. **When a glass fireplace enclosure (door) is used, leave the doors fully open when the system is in operation.**
- O. This appliance may be installed in an aftermarket, permanently located, manufactured (mobile) home, where not prohibited by local codes. Installation of appliances designed for manufactured home (U.S. only) or mobile home installation must conform with the Standard *CAN/CSA Z240 MH, Mobile Housing*, in Canada, or with the *Manufactured Home Construction and Safety Standard, Title 24 CFR, Part 3280*, in the United States, or when such a standard is not applicable, *ANSI/NCSBCS A225.1/NFPA 501A, Manufactured Home Installations Standard*.
- P. PETERSON (REAL FYRE) GLASS OR GEMS ARE THE ONLY MEDIA CERTIFIED TO BE USED IN THIS BURNER. DO NOT USE ANY OTHER MEDIA. Correct installation of the glass/gems and proper placement and installation of the burner assembly, are imperative to safe operation of your appliance. Problems **WILL** occur if all items are not properly installed.
- Q. The correct amount of glass/gems **must** be used on your burner system for it to operate properly. You may use additional glass/gems, or lava granules to cover the floor of the fireplace. Please read the entire DECORATIVE MEDIA PLACEMENT section for details.

SPECIFICATIONS

Real-Fyre gas burner systems must be installed only in a wood burning fireplace with the minimum firebox dimensions and venting requirements met (see table on this page). This appliance is designed to burn with yellow flames; adequate ventilation is absolutely necessary.

Burner Model	Minimum Fireplace Size				BTU Rating
	Width		Depth	Height	Natural Gas
	Front	Rear			
G22-GL-18(G)	23"	16"	13"	15"	40k
G22-GL-24(G)	29"	20"	13"	15"	55k
G22-GL-30(G)	35"	27"	13"	15"	65k

Note: Rear width is at corresponding depth.

Minimum permanent free opening area of chimney damper for venting (sq. in.)			
For factory-built fireplaces *			
Chimney height	18"	24"	30"
15'	18	24	30
20'	15	21	25
30'	12	16	19

* For masonry-built fireplaces, add 5 sq. in. to amount shown

Note: The minimum chimney height from hearth to top of chimney is 15'.

DAMPER CLAMP INSTRUCTIONS

The damper clamp with hex bolt (Fig. 4-2) is provided as a means to prevent full closure of the damper blade. The clamp is easily attached to most damper blades with pliers or a wrench, and must be permanently installed. The clamp is designed to prevent accidental closure of the damper when installed as illustrated (Fig. 4-3 and Fig. 4-4). Should the clamp not fit, or fail to provide the permanent vent opening listed in the table found above, have a permanent stop installed, remove the damper blade, or have the damper cut to provide the minimum permanent opening required.

Note: These are minimum damper opening specifications. The damper must be completely opened when operating this gas appliance to achieve the best ventilation possible.

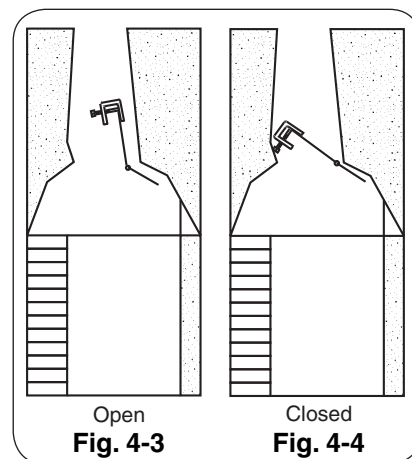
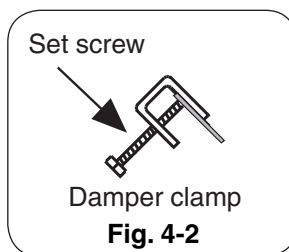

BURNER PARTS LIST

Note: Photos not to scale

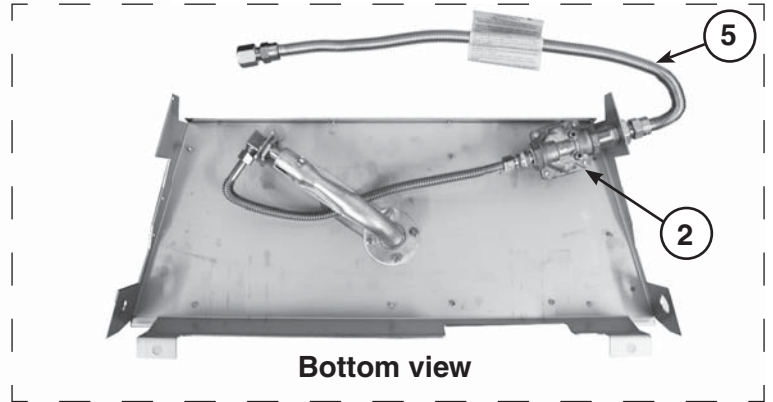
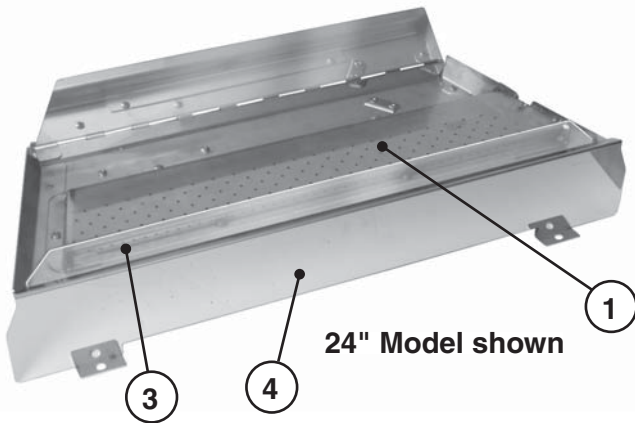

Replacement parts can be ordered from your local Real-Fyre dealer.



Item	Description	18" model		24" model		30" model	
		Part No.	Qty.	Part No.	Qty.	Part No.	Qty.
1.	Burner assembly (w/ venturi tube)	G22-07-18	1	G22-07-24	1	G22-07-30	1
2.	Regulator	PR-3NAT	1	PR-3NAT	1	PR-3NAT	1
3.	Glass panel	G22-06-18	1	G22-06-24	1	G22-06-30	1
4.	Reflective front cover (removable, shown installed) or Rose gold reflective front cover	G22-03-18 G22-03G-18	1 1	G22-03-24 G22-03G-24	1 1	G22-03-30 G22-03G-30	1 1
5.	24" flex connector (w/ adapter)	3035	1	3035	1	3035	1
6.	Damper clamp	DC-1	1	DC-1	1	DC-1	1
7.	Hammer screws (pair)	G21-05	1	G21-05	1	G21-05	1

Glass/gems are purchased & packaged separately. Amount varies depending on model size;

18"	10.0 lbs [(1) 10 lb bag]
24"	12.5 lbs [(1) 5 lb bag & (1) 7.5 lb bag]
30"	15.0 lbs [(2) 7.5 lb bags]

Glass/gems are available in 5, 7.5, or 10 lb bags, in various colors; contact your dealer for further details.

BURNER INSTALLATION

The Real-Fyre burner system must be installed by a qualified professional service technician. Instructions must be followed carefully to ensure proper performance and full benefit from the burner system. **Check to be sure the burner system is designed and labeled for the type of gas (natural gas only) supplied to the fireplace. Fireplace floor must be level, clean, and smooth.**

WARNING: Failure to position the parts in accordance with these diagrams or failure to use only parts specifically approved with this appliance may result in property damage or personal injury.

Important: When the burner system is installed outdoors, ensure it is not directly exposed to the elements (precipitation, rain, wind, etc.).

REFER TO THE BURNER PARTS LIST WHEN FOLLOWING THESE INSTRUCTIONS.

1. MAKE SURE THE FIREPLACE GAS SUPPLY IS TURNED OFF.
2. Locate the gas-supply stub inside the fireplace and remove the cap, if attached (reference Fig. 6-1).

CAUTION: When removing the cap, make sure the stub does not turn, loosening the connection inside the wall.

3. Place the burner system in the fireplace. Center the burner in the fireplace. (Reference Fig. 6-2 for orientation.)
4. **Be sure gas to the fireplace is off.** Remove the adapter that is loosely connected to the flex connector (coming off of the burner system). Attach the adapter to the gas-supply stub using a pipe compound resistant to all gasses. Tighten securely. Then attach the open end of the flex connector to the adapter. Tighten securely (See Fig. 6-1).
5. **LEAK TEST:** Use a long-necked butane lighter, or lay a lighted match next to the burner pipe, and carefully turn on the gas supply until the burner ignites. Test at all connections for leaks using the appropriate soapy water solution. If bubbles appear, a leak is present. Turn off the gas and tighten at all connections. Repeat until no leaks are present. If a leak persists, turn off the gas supply and contact the local gas company or dealer. **NEVER USE A FLAME TO CHECK FOR LEAKS.**

Turn off the gas supply prior to proceeding.

6. The burner system must be secured to the fireplace floor. The unit has two anchoring tabs located at the bottom front. With the unit centered, mark and then drill two $\frac{1}{4}$ " pilot holes.
7. Reposition the burner over the pilot holes and insert the provided hammer screws. Carefully hammer the screws in as shown in Fig. 6-3.
8. Use a power drill to complete the fastening of the screws (Fig. 6-4).

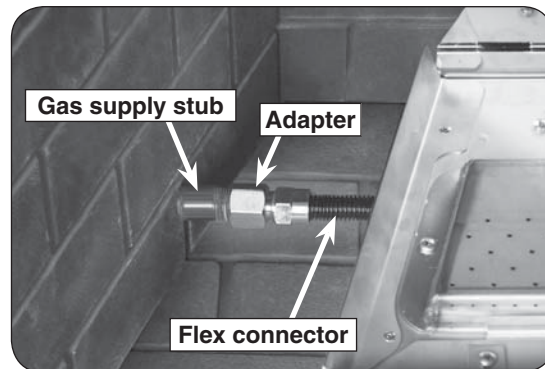

Fig. 6-1 Connect gas supply

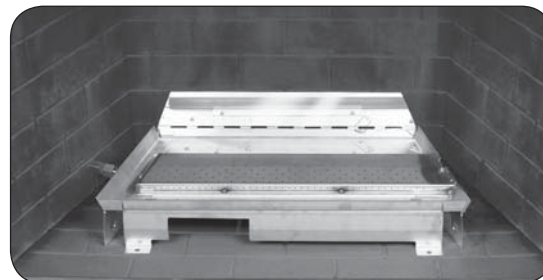

Fig. 6-2 Orientation

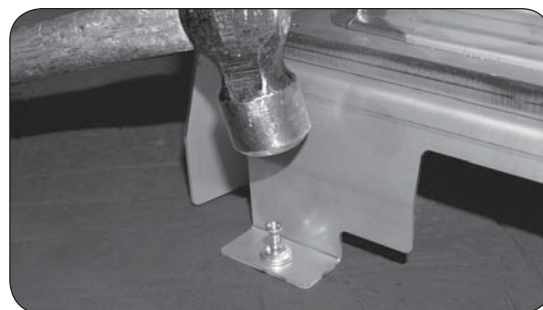

Fig. 6-3 Installing hammer screws



Fig. 6-4 Fastening hammer screws

BURNER INSTALLATION (cont.)

Note: Should the burner need to be removed for **servicing**; first unfasten the screw, then use a flat head screwdriver to pry up the anchoring tab until the wedge anchor pops out. See Fig.7-1. The screw assembly is reusable.

9. The front of the burner has tabs designed to hold the glass panel in place. First loosen the screws on the tabs with a screwdriver. Then position the glass panel in place, secure the tabs up against the panel, and fasten the screws. Reference Fig. 7-2 and Fig. 7-3.
10. Remove the protective coating off of the reflective rear panel and front cover. **DO NOT** use a sharp object to remove coating. Install the front cover onto the front of the burner system (see Fig. 7-4).

Turn off the gas supply prior to proceeding.

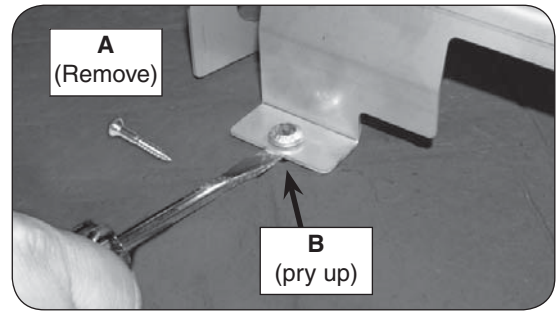

Fig. 7-1 If removal is required

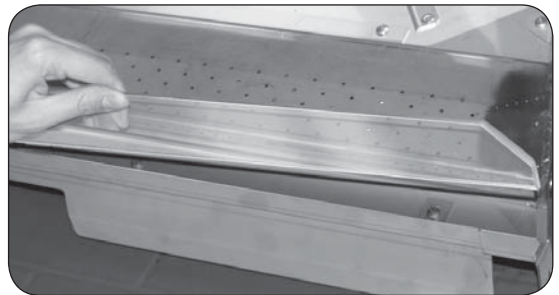

Fig. 7-2 Glass panel positioning



Fig. 7-3 Securing glass panel

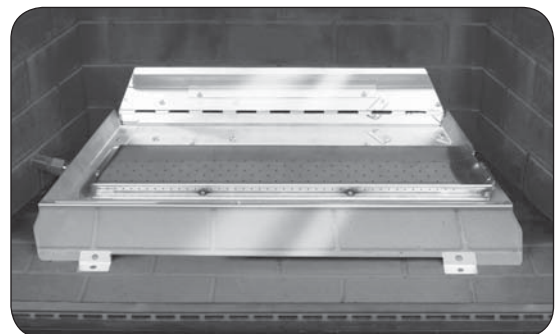

Fig. 7-4 Front cover installed

DECORATIVE MEDIA PLACEMENT

GLASS/GEMS PLACEMENT (purchased separately)

CAUTION: Glass pieces may have sharp edges. Be careful handling the glass. Use hand protection, such as gloves, if necessary.

Glass/gems (purchased separately) must be installed on the burner for the system to operate properly. See the table below for correct amounts of media for each model. Glass/gems are available in various colors; contact your dealer for further details.

Pour the glass/gems directly on top of the burner so that the burner pan is covered completely and evenly (see Fig. 8-1).

Model Size	Correct Amount of Fyre Glass/Gems to Use
18"	10.0 lbs
24"	12.5 lbs
30"	15.0 lbs

Important: DO NOT block the rear vents of the burner system with glass/gems (see Fig. 8-2).

Important: When installing glass on your burner; DO NOT use the fine glass particles that have settled at the bottom of the glass bag. These particles will adversely affect the flame pattern.

Important: Do not add any additional glass/gems to this burner system. Any additional glass/gems may cause unsafe operation.

WARNING: All previously applied loose material must be removed prior to reapplication. All replacement loose material must be purchased from the R.H. Peterson Co.

DECORATIVE MEDIA ON FIREPLACE FLOOR (optional)

Glass, gems, or Lava-Fyre Granules may be placed on the fireplace floor as an enhancement to the burner system.

If purchased; spread the decorative media on the floor of the fireplace, around the front and sides of the burner system. See Fig. 8-3 for an example (reflective black glass shown).

CAUTION: DO NOT place any of this additional media into or onto the burner system, or behind it.

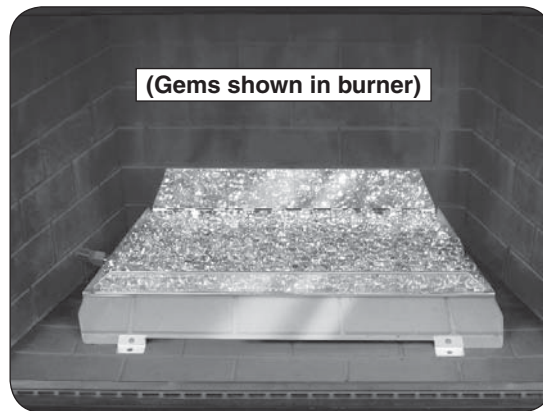

Fig. 8-1 Glass/gems placement

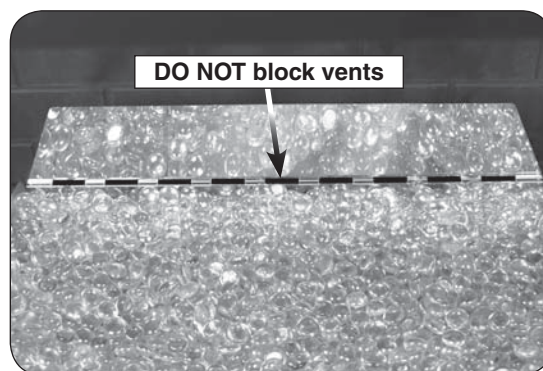

Fig. 8-2 Keep rear vents clear



Fig. 8-3 Decorative media floor placement

CAUTION: BURN HAZARD. GLASS AND/OR GEMS ON BURNER SYSTEM WILL REMAIN HOT FOR SOMETIME AFTER USE. You must maintain the placement as shown to ensure proper operation of the burner system. If you need to reposition any media to maintain the proper layout, use heat-resistant gloves or allow media adequate time to cool before handling.

LIGHTING INSTRUCTIONS

FOR YOUR SAFETY, READ BEFORE LIGHTING

WARNING: If you do not follow these instructions exactly, a fire or explosion may result, causing property damage, personal injury, or loss of life.

Use only a proper key to turn the gas supply valve. Never use tools. If the valve will not turn, **DO NOT** try to repair it. Call a qualified professional service technician. Force or attempted repair may result in fire or explosion.

BEFORE LIGHTING, smell all around the burner area for gas. Be sure to smell next to the floor, as some gas is heavier than air and will settle on the floor. IF YOU SMELL GAS, FOLLOW THE INSTRUCTIONS ON PG. 1.

1. **STOP!** Read the safety information above.
2. Insert the key into the key valve and completely turn the valve clockwise toward the **OFF** position until it no longer rotates.
3. Wait 5 minutes for the gas to clear out.
4. Lay a lighted long-stem match on the surface of the decorative media near the burner (**do not hold the match in your hand**) or use a lighted long-necked butane lighter (Fig. 9-1).
5. **Once the match is burning and in position**, slowly turn the key valve counter-clockwise toward the **ON** position until it no longer rotates (see Fig. 9-2). Your burner should light.

CAUTION: If the burner does not light before the match goes out, immediately turn the key valve clockwise toward the **OFF** position until it no longer rotates.

Wait approximately five (5) minutes to clear out any gas, and repeat steps 1-5 above.

If your burner fails to light again, turn the key valve clockwise toward the OFF position until it no longer rotates and contact your dealer or gas supplier.

TO SHUT OFF GAS TO THE APPLIANCE

To extinguish your gas burner, insert the key into the key valve and turn the valve clockwise toward the **OFF** position until it no longer rotates. Be sure the control knob is turned fully off to avoid any gas leakage.

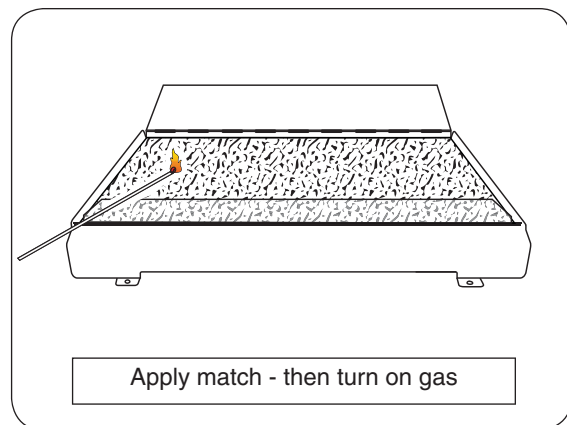

Fig. 9-1

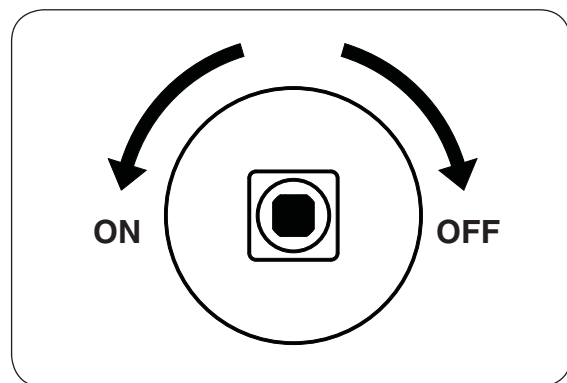

Fig. 9-2

CLEANING AND SERVICING SAFETY INFORMATION

Note: Regular cleaning and servicing will be necessary to ensure proper operation and burn characteristics. Always shut off the gas to the appliance while performing service work. Allow the appliance to cool before servicing.

Installation, service, and repair must be done by an NFI Certified or other qualified professional service technician. The appliance MUST be inspected before use, and cleaned at least annually to prevent burner shutdown, sooting, odors, etc. by a qualified professional service technician. It must be checked for clean burning operation with the correct tools to service this unit. More frequent cleaning may be required. Excessive lint can build up on this unit from carpeting, bedding material, pet hairs, or other particles in the air. It is imperative that all components and compartments, burner(s), air shutters, and circulating air passageways of the appliance be kept clean and free of all obstructions.

In addition, a periodic examination and cleaning of the solid-fuel-burning fireplace venting system should be conducted by a qualified professional service technician.

Any safety screen or guard removed for servicing must be replaced prior to operating this appliance.

TO CLEAN THE BURNER SYSTEM

1. Remove the glass/gems. Use a vacuum cleaner to remove loose particles from all surfaces of the burner system. Do not use cleaning fluids.
2. Dust the assembly and the burner. Using a compressed air duster (commonly available at computer, electronic, or office supply stores); blow through all of the burner ports.
3. Reinstall the glass/gems as instructed in this manual.

If, after a period of use, the flames start to exhibit unusual shapes and behavior, or the burners fail to ignite smoothly, the burner ports may require some cleaning. If this happens, it is preferable to contact the nearest dealer to get the appliance serviced.

Do not remove the rating plates or the warning tags. These are an integral safety and identification component of this appliance.

We recommend following these instructions at the beginning of each fireplace season and as needed throughout the year, depending on your usage pattern and the environmental conditions in your home.

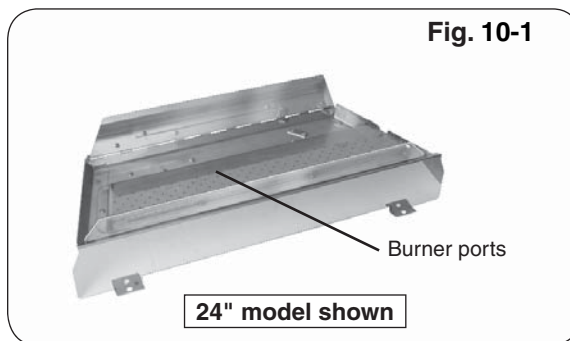

FLAME DESCRIPTION

Observe the flames. The main burner flames should be blue at the base and a combination of blue/yellow at the body and at the tips. They should be approximately 8" above the glass/gems, with the center flame being the tallest. (See cover photo for example.)

TROUBLESHOOTING

POSSIBLE CAUSE	SOLUTIONS
1 BURNER SHUTTING DOWN DURING OPERATION	
A. Insufficient or excessive gas pressure	A1. Check gas pressure (Read G.- I. of IMPORTANT PRE-INSTALLATION AND FIREPLACE SAFETY INFORMATION section, & <u>check with local gas company</u>). A2. Other gas appliances may be on the same gas line, dropping gas pressure to the burner. Check pressures with everything operating to ensure adequate pressure.
B. Flue area, fireplace, or damper dirty from soot	B. Clean around, above, and under damper thoroughly. Clean fireplace, removing loose material, including soot and creosote.
C. Fireplace too small for unit	C. Ensure minimum requirements are met. (See FIREPLACE SIZE REQUIREMENT section in this owner's manual.)
2 LOW FLAME HEIGHT	
A. Gas pressure	A. Check gas pressure (see Section 1, A1 of this table).
3 BURNER NOT BURNING EVENLY	
A. Burner orifice clogged	A. Clean burner orifice.
4 ODORS	
A. Gas leak	A. Shut off gas, if possible. Follow instructions on front page. Have a qualified professional installer or the gas company correct all leaks.
B. New home, new carpet, or new paint	B. When these odors are drawn into the fireplace, this may cause objectionable odors. Thoroughly ventilate the area before restarting your burner system.
5 SOOTING	
A. Low gas pressure	A. Check gas pressure (see Section 1, A1 of this table).
B. Drafts in room	B. Eliminate drafts by closing heating and air conditioning vents, returns, and outside air vents. Fans blowing directly into fireplace should be turned off when set is operating.
C. Air shutters blocked (if applicable)	C. Air shutters are blocked with debris. Vacuum debris away from air shutter.
D. Using a product other than Real-Fyre® glass/gems with burner	D. Make sure only Real-Fyre® glass/gems are used with your burner.
E. Using natural-gas burner on propane gas	E. If the gas listed on the nameplate does not match the gas you are burning, shut down the burner system immediately and completely following the steps in the LIGHTING INSTRUCTIONS section. Then call your dealer.
F. Adding any accessories to burner system	F. Shut down burner and take off any accessories that do not belong with the system.

WARRANTY

PETERSON VENTED DECORATIVE GAS APPLIANCE LIMITED WARRANTY

Robert H. Peterson Co. ("RHP") warrants your Real Fyre® vented decorative gas appliance to be free from defects in material and workmanship.

Peterson vented ceramic refractory gas logs are warranted for **as long as you own them (lifetime)**.

Peterson vented burner assemblies are **WARRANTED for TEN (10) YEARS**. Peterson vented outdoor stainless-steel burner assemblies are warranted for **FIVE (5) YEARS**.

Peterson glass, gems, nuggets, and fiber-ceramic blend gas logs are warranted for **FIVE (5) YEARS**.

SPK-26 controls are warranted for **THREE (3) YEARS**.

APK-17 controls (including -17 valve) are warranted for **TWO (2) YEARS**.

All other Peterson valves, pilots, and controls are warranted for **ONE (1) YEAR (excluding batteries)**.

A COPY OF YOUR SALES SLIP FOR PROOF OF PURCHASE IS REQUIRED

This warranty applies to the original purchaser for products which are installed in the United States or Canada and which are operated and maintained as intended for single family residential usage. This warranty is valid only with proof of purchase, shall commence on the date of purchase, and shall terminate (both as to original and any replacement products) on the anniversary date of the original purchase of the product stated on the above schedules.

This warranty covers defects in material and workmanship. This warranty **does not** cover parts which become defective as a result of negligence, misuse, use not in compliance with the Owner's Manual/Installation Instructions, accidental damage, improper handling, improper storage, improper installation, lack of required routine maintenance (as specified in the Owner's Manual/Installation Instructions), electrical damage, local gas impurities or failure to protect against combustibles. Product must be installed (and gas must be connected) as specified in the Owner's Manual/Installation Instructions by a **qualified professional installer**. Modifications to products which are not specifically authorized will void this warranty. Accessories, parts, valves, remotes, etc. when used must be Peterson products or this warranty is void. Warranted items will be repaired or replaced at Peterson's sole discretion. This warranty **does not** apply to rust, corrosion, oxidation, or discoloration unless the affected part becomes inoperable.

This warranty **does not** cover labor or labor related charges, except as provided by separate specific written programs from the Peterson Co. All repair work must be performed by a qualified professional service person and requires prior approval of Peterson.

Peterson may require the defective product or part to be returned to the factory to determine the cause of failure. Peterson will pay freight charges if the product or part is determined to be defective. This warranty does not cover breakage in shipment from our (Independent) distributor to its customer if the damage is determined to have occurred during that shipment.

This warranty specifically excludes liability for **indirect, incidental, or consequential** damages. Some states and provinces do not allow the exclusion or limitation of incidental or consequential damages, so the above exclusion may not apply to you. This warranty gives you specified legal rights, and you may have other rights that vary from state to state or province.

For additional information regarding this warranty, or to place a warranty claim, contact the R. H. Peterson dealer where the product was purchased.

**TO REGISTER YOUR PRODUCT ONLINE GO TO: WWW.RHPETERSON.COM,
AND CLICK ON PRODUCT REGISTRATION. THANK YOU FOR YOUR PURCHASE.**

FOR USE IN THE COMMONWEALTH OF MASSACHUSETTS

**INSTALLATION OF THIS APPLIANCE MUST BE PERFORMED BY A MASSACHUSETTS
LICENSED PLUMBER OR GAS FITTER ONLY.**

**CONNECTOR KITS USED FOR INSTALLATION AND OPERATION OF THIS APPLIANCE
MUST NOT BE MORE THAN 36" IN LENGTH.**

**FIREPLACE DAMPER MUST BE REMOVED OR PERMANENTLY FIXED/WELDED IN FULL
OPEN POSITION PRIOR TO INSTALLING THIS PRODUCT.**

Quality Check

Date: _____

Burner Orifices	Nat.	L.P.	Leak Test:	_____	Model#:	_____
Main:	_____	_____	Burn Test:	_____	Serial#:	_____
Other:	_____	_____	Gas Type:	Nat. / L.P.	Air Shutter:	_____
					Inspector:	_____