

Burner Systems:

- G9-20/24/30(P)
- G9-20/24/30-12(M)(P)
- G9-20/24/30-15(M)(P)

Log Sets:

- RD9-(20,24,30) Golden Oak Designer
- S9-(20,24,30) Split Oak
- FO9-(20,24,30) Forest Oak



**DESIGN CERTIFIED
 to standards:**

- Unvented Room Heater
 ANSI Z21.11.2-2013
 and
- Vented Decorative Appliance
 ANSI Z21.60-2012

G9 SERIES UNVENTED GAS LOG SETS

INSTALLER: Leave this manual with the appliance
CONSUMER: Retain this manual for future reference

Installation and service must be performed by a qualified professional installer, service agency, or the gas supplier.

⚠ WARNING: If the information in this manual is not followed exactly, a fire or explosion may result, causing property damage, personal injury, or loss of life.

Do not store or use gasoline or other flammable vapors and liquids in the vicinity of this or any other appliance.

WHAT TO DO IF YOU SMELL GAS:

- Open a window.
- Do not try to light any appliance.
- Do not touch any electrical switch; do not use any phone in your building.
- Immediately call your gas supplier from a neighbor's phone. Follow the gas supplier's instructions.
- If you cannot reach your gas supplier, call the fire department.

It is imperative that you maintain your unvented gas appliance by having it cleaned and serviced regularly. See pages 11, 20 & 21 for details.

Important

Read these instructions carefully and completely before starting installation of the burner system.

This appliance may be installed in an aftermarket, permanently located, manufactured (mobile) home where not prohibited by local codes.

This appliance is only for use with the type of gas indicated on the rating plate. This appliance is not convertible for use with other gasses.

This is an **UNVENTED** gas-fired heater. It uses air (oxygen) from the room in which it is installed. Provisions for adequate combustion and ventilation air **MUST** be provided. See section entitled **VENTILATION AND CONFINED SPACE INFORMATION**.

This appliance is designed as an **attended appliance**. Adults must be present when the unit is operating. Do not leave this unit burning when unattended or while anyone is sleeping.

Installation, service, and the provisions for combustion and ventilation air **MUST** conform with local codes and with the *National Fuel Gas Code*, ANSI Z223.1/ NFPA 54, or the *CSA B149.1, Natural Gas And Propane Installation Code*.



TABLE OF CONTENTS

3	SPECIFICATIONS AND REQUIREMENTS
4	IMPORTANT SAFETY INFORMATION
5	VENTILATION AND CONFINED SPACE SAFETY INFORMATION
6	MINIMUM CLEARANCES TO COMBUSTIBLES
8	PRE-INSTALLATION AND FIREPLACE PREPARATION SAFETY
9	INSTALLATION SAFETY INFORMATION
10	OPERATIONAL SAFETY INFORMATION
11	CLEANING AND SERVICING IMPORTANT INFORMATION
12	BURNER PARTS LIST
13	LOGS PARTS LIST
14	WHEN USED AS A VENTED DECORATIVE APPLIANCE (PER ANSI Z21.60)
14	INSTALLATION
15	REMOTE SYSTEM (if equipped)
15	SECURE BURNER TO FLOOR
15	LIGHTING TEST
16	CHECKING GAS PRESSURE
16	GAS PRESSURE SPECIFICATIONS
17	LOG PLACEMENT
18	GLOWING EMBER PLACEMENT
18	LAVA GRANULES PLACEMENT
19	CONTROL SETTINGS
19	DAMPER CLAMP INSTRUCTIONS (IF APPLICABLE)
20	CLEANING AND SERVICING SAFETY INFORMATION
21	CLEANING AND SERVICING
21	TO CLEAN THE LOG SET
21	CLEANING AND SERVICING THE ODS PILOT
22	OPERATING THE UNVENTED GAS LOG SET
22	CHECKING THE ODS PILOT FLAME APPEARANCE
23	LIGHTING INSTRUCTIONS - SERIES 12 VALVE
24	LIGHTING INSTRUCTIONS - SERIES 15 VALVE
25	LIGHTING INSTRUCTIONS - MANUAL VALVE
26	NOTES PAGE
27	TROUBLESHOOTING
30	WARRANTY

SPECIFICATIONS AND REQUIREMENTS

WARNING: This appliance is for installation only in a:

1. Solid-fuel-burning masonry or UL-127 factory-built fireplace, or
2. Listed ventless firebox enclosure.

It has been designed certified for these installations. Exception: DO NOT install this appliance in a factory built fireplace that includes instructions stating it has not been tested or should not be used with unvented gas logs.

Note: Installation in any other fireplace is prohibited and will void any approvals and warranties.

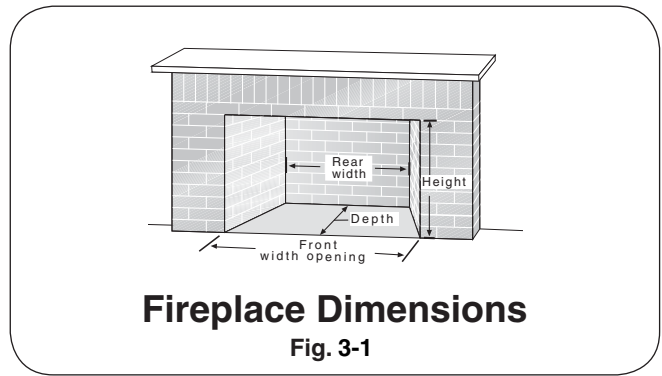

Any installation of this appliance is subject to minimum fireplace size requirements below:

Log Set Size	Minimum Fireplace Size (refer to Fig. 3-1)				BTU Input Rating			
	Width		Depth	Height	High Setting		Low Setting	
	Manual valve	Millivolt valve			Millivolt valve	Manual valve	Millivolt valve	Manual valve
20"	24" front 20" rear *	26" front 22" rear *	14"	18"	36k	36k	21k	17k
24"	29" front 20" rear *	30" front 22" rear *	14"	18"	36k	36k	21k	17k
30"	34" front 26" rear *	34" front 26" rear *	14"	18"	36k	36k	21k	17k

* based on minimum depth

G9 Series vent-free gas log sets are available with a variable flame-height control valve that can be used with the optional remote transmitter and receiver.

This burner system is equipped with an Oxygen Depletion Sensor (ODS) safety pilot system. The ODS senses the amount of oxygen available in the room and shuts the burner system off before the oxygen level drops below 18%. The pilot can only be relit when fresh air is available. **This may require opening a window or a door to another room or cracking the damper open slightly.**

This gas log set has been certified to two standards:

UNVENTED ROOM HEATER-ANSI Z21.11.2

VENTED DECORATIVE APPLIANCE-ANSI Z21.60

Check local or state codes to determine if vent-free heaters are permitted in your area before you install this log set as a vent-free appliance. If not permitted, you may install and operate this log set as a vented appliance.

This unit may not be installed in a vented fireplace with a chimney of less than 15 feet in height.

Observing minimum fireplace dimensions and centering the appliance in the fireplace will ensure adequate clearance for operation and servicing. It may be necessary to disconnect the unit for some types of service.

Minimum Permanent Chimney Vent Opening in sq. in. (when used as a vented appliance)

Table 3-1 Chimney Height	Factory built fireplaces	Masonry built fireplaces
15'	16	24
20'	13	22
25'	12	-
30'	11	20

Specification	Value	Qty.
Remote receiver battery type	AA battery	4
12 and 15 Models remote transmitter battery type	12V battery	1

Table 3-2 - Technical Data (if applicable)

IMPORTANT SAFETY INFORMATION

UNVENTED ROOM HEATER GENERAL SAFETY INFORMATION

A. **WARNING: CARBON MONOXIDE POISONING MAY LEAD TO DEATH.**

Early signs of carbon monoxide poisoning are similar to the flu, with headaches, dizziness, and/or nausea. If you have these signs, the gas appliance may not be installed correctly, or may not be working properly. **GET FRESH AIR AT ONCE! STOP USING THE APPLIANCE IMMEDIATELY!** Some people, including pregnant women; persons with heart or lung disease, asthma, or anemia; those under the influence of alcohol; and persons at high altitudes, are more affected by carbon monoxide than others. **(The appliance must be serviced by a qualified professional service technician before use).**

- B. If any soot appears on the appliance or other areas of the fireplace in which this appliance is installed, shut system off and call a qualified professional service technician, **vent-free gas burner system technician**, or your local gas company.
- C. This appliance may be installed in an aftermarket, permanently located, manufactured (mobile) home where not prohibited by local codes. Installation of appliances designed for manufactured homes or mobile homes must conform with the *Manufactured Home Construction and Safety Standard, Title 24 CFR, Part 3280* in the U.S.; or with *CAN/CSA Z240 MH, Mobile Housing* in Canada; or with *ANSI/NCSBCS A225.1/NFPA 501A, Manufactured Home Installations Standard* when none of the previously referenced standard are applicable.
- D. Eliminate drafts **before** using the gas appliance by closing heating and air conditioning vents, returns, and outside air vents. Fans blowing directly into the fireplace must be turned off when this appliance is operating.
- E. **WARNING:** This appliance is for installation only in a solid-fuel-burning masonry or UL 127 factory-built fireplace or in a listed ventless firebox enclosure. It has been design certified for these installations. Exception: DO NOT install this appliance in a factory-built fireplace that includes instructions stating it has not been tested or should not be used with unvented gas burner systems.
- F. **WARNING: DO NOT MODIFY THIS VENT-FREE HEATER OR ITS CONTROLS. Any change may be dangerous.** Improper installation or use of your vent-free gas appliance can cause serious injury or death from fire, burns, explosions, or carbon monoxide poisoning.
- G. State and local codes may only allow operation of this appliance in a vented configuration. Check your state or local codes.
- H. WHEN INSTALLING AS A DECORATIVE VENTED APPLIANCE, THE UNIT MUST CONFORM TO ALL LOCAL CODES AND TO THE LATEST EDITION OF THE NATIONAL FUEL GAS CODE ANSI Z223.1/NFPA54.

Important: For safe operation and proper performance of this product and to comply with certification, listings, and building code acceptances, use ONLY Peterson Real Fyre controls, parts, and accessories that have been specifically listed or certified for use with this burner system. Use of other controls, parts, or accessories is prohibited and will void all warranties, certifications, listings, and building code approvals, and may cause property damage, personal injury, and loss of life.

VENTILATION AND CONFINED SPACE SAFETY INFORMATION

Your vent-free gas burner system **SHALL NOT BE INSTALLED IN A CONFINED SPACE** or unusually tight construction unless provisions are made for adequate combustion and ventilation air.

- The National Fuel Gas Code, ANSI Z223.1/NFPA 54 defines a confined space as a space whose volume is less than 50 cu. ft. per 1,000 BTU per hour (4.8 meters³ per kw) of the aggregate input rating of all appliances installed in that space.
- An unconfined space is a space where volume is at least 50 cu. ft. per 1,000 BTU per hour (4.8 meters³ per kw) of the aggregate input rating of all appliances installed in that space.
- Rooms communicating directly with the space in which the appliances are installed, through openings not furnished with doors, are considered a part of the unconfined space.

WARNING: Do not install the unvented burner system where the room is considered a confined space (see Fig. 5-1).

To determine if the area where this burner system is to be installed fits the definition of an unconfined space, multiply the length of the room by the width of the room by the height of the room, then multiply by 20. The result is the maximum BTU allowed.

(Length x Width x Height x 20 = Maximum BTUs allowed)

Example: To install a Peterson Real Fyre vent-free gas burner system with 36,000 BTU, maximum, in a space with no other gas-burning appliances, the space **MUST** be 1,800 cu. ft. or larger.

Assuming an 8' ceiling, floor dimensions must be a minimum of 225 sq. ft.,
i.e.; 18'x12.5'=225 sq ft (see Fig. 5-1).

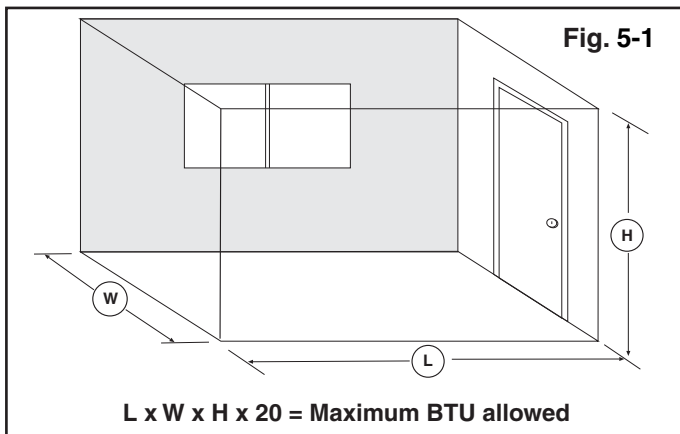

WARNING

If the area in which the heater may be operated is smaller than that defined as an unconfined space or if the building is of unusually tight construction, provide adequate combustion and ventilation air by one of the methods described in the National Fuel Gas Code, ANSI Z223.1/NFPA 54, Air for Combustion and Ventilation, or applicable local codes.

REMEMBER

$L \times W \times H \times 20 = \text{MAXIMUM BTUs ALLOWED}$

If the space is smaller than the above formula allows, and/or smaller than the examples and diagrams on this page specify, **DO NOT** install the vent-free burner system unless provisions for additional combustion and ventilation air are made.

IT MAY BE NECESSARY TO OPEN A WINDOW SLIGHTLY (1" - 2") OR OTHERWISE INCREASE VENTILATION. CONDITIONS REQUIRING THIS INCLUDE, BUT ARE NOT LIMITED TO:

1. Installation in a **CONFINED SPACE.**
2. Installation in a **HOME OF UNUSUALLY TIGHT CONSTRUCTION**.**
3. Installation at **HIGH ALTITUDES.**
4. **Certain MEDICAL OR PHYSICAL CONDITIONS OF THE HOMEOWNER that may be adversely impacted by combustion products created by burning natural or propane gas.**

Installation in a tightly constructed home and/or installation at high altitudes may cause your vent-free burner system to produce excessive heat or excessive moisture. The oxygen depletion sensor may shut down the burner system. These conditions may be corrected by opening a window or otherwise increasing the number of air changes in the home.

**Unusually tight construction is defined as construction where:

- a. Walls and ceilings exposed to the outside atmosphere have a continuous water vapor retarder with a rating of 1 perm (6×10^{-11} kg per pa-sec- m^2), or less with openings gasketed or sealed;
- b. Weather stripping has been added on openable windows and doors, and
- c. Caulking or sealants are applied to areas such as joints around window and door frames, between sole plates and floors, between wall-ceiling joints, between wall panels, at penetrations for plumbing, electrical, and gas lines, and at other openings.

The Peterson Real Fyre vent-free burner system has been certified to function safely and reliably with emission by-products well within accepted safety and health standards. **Your specific medical or physical condition** may render you more sensitive to products created by burning natural or propane gas. If this is the case, you should open a window or otherwise increase ventilation.

MINIMUM CLEARANCES TO COMBUSTIBLES

If the vent-free burner system is installed in a factory built fireplace, follow the manufacturer's guidelines for minimum clearances to combustibles.

In the absence of such guidelines, follow the instructions below:

Clearances to Combustible Construction:

Sidewalls: 6" from side of fireplace opening (Fig. 6-1).

Ceiling: 42" from top of fireplace opening (Fig. 6-1).

Flooring: See IN FRONT OF FIREPLACE section below.

Mantel: See ABOVE THE FIREPLACE section below & Fig. 6-1. Also see Fig. x-1, & x-2 on following page).

Note: Clearances to combustible construction are those distances required to ensure that fireplace mantels, facings, walls, ceilings, and floorings will not catch fire.

In most cases, these clearances should also be adequate to prevent any discoloration or warping due to heat. However, every gas burner installation presents a different and unique set of circumstances involving many variables beyond the control of the manufacturer. These include paint or finish composition, previous exposure to heat, methods and quality of construction, air flow patterns, glass doors, fans or blowers, etc.

IN FRONT OF THE FIREPLACE:

Be certain that combustible flooring material (i.e.: carpet, tile, etc.) is not too close to the vent-free unit. If the vent-free burner system is at floor level or less than 6" above the floor, there **MUST** be at least 12" (1 foot) of noncombustible material between the front of the fireplace and any combustible flooring.

ABOVE THE FIREPLACE:

To install the vent-free burner system, there must **ALWAYS** be noncombustible or heat resistant material immediately above the fireplace opening. Heat resistant materials (i.e., marble or slate) must be at least $\frac{5}{8}$ " thick. Sheet metal should not be installed onto combustible materials.

If you **DO NOT** install a fireplace hood, there **MUST** be at least 12" of noncombustible or heat resistant material immediately above the fireplace opening (**see A** in Fig. x-1 on the following page). If you **DO** install a fireplace hood, there **MUST** be at least 10" of noncombustible or heat resistant material immediately above the fireplace opening (**see B** in Fig. x-2 on the following page). If there is a wooden mantel, shelf, or other combustible projection above the fireplace, follow the information in the Figures on the next page.

EXAMPLE: If the fireplace has a combustible projection (mantel or shelf) 20" above the top of the firebox, the maximum horizontal projection out from the face of the fireplace will be:

1. If a fireplace hood is not installed - **2.5"** (see Fig. x-1 on the following page).
2. If a fireplace hood is installed ----- **10"** (see Fig. x-2 on the following page).

A fireplace hood deflects heat away from the fireplace face and mantel, reducing the potential for heat related warping or discoloration. The use of a fireplace hood is highly recommended.

DO NOT place any combustible decorations/items on the mantel or above the fireplace.

IF YOU CANNOT MEET THESE MINIMUM CLEARANCES, YOU MUST OPERATE THE VENT-FREE BURNER SYSTEM WITH THE CHIMNEY FLUE DAMPER OPEN.

Because of these variables, we cannot guarantee that heat warping or discoloration will never occur. The potential for heat warping or discoloration may exist no matter what item(s) you are burning in the fireplace, including wood.

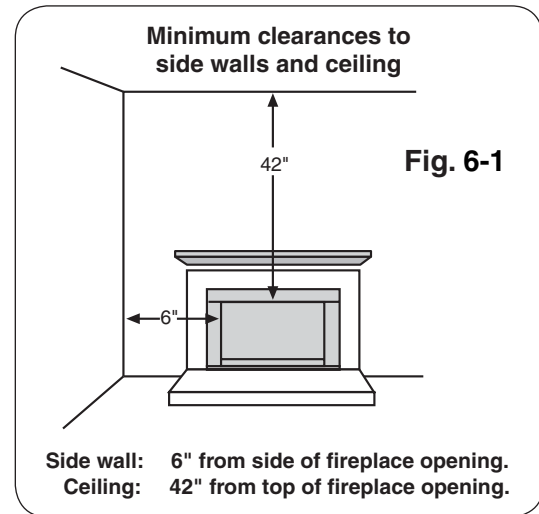

The dimensions in Fig. 6-1 are **MINIMUM CLEARANCES** to maintain when you install this burner system. **BOTH SIDES** of the fireplace opening **MUST BE AT LEAST 6"** from any combustible sidewalls. The ceiling **MUST BE** at least 42" from the top of the fireplace opening.

MINIMUM CLEARANCES TO COMBUSTIBLES (Cont.)

IF YOU CANNOT MEET THESE MINIMUM CLEARANCES, YOU MUST OPERATE THE VENT-FREE GAS BURNER SYSTEM WITH THE CHIMNEY FLUE DAMPER OPEN.

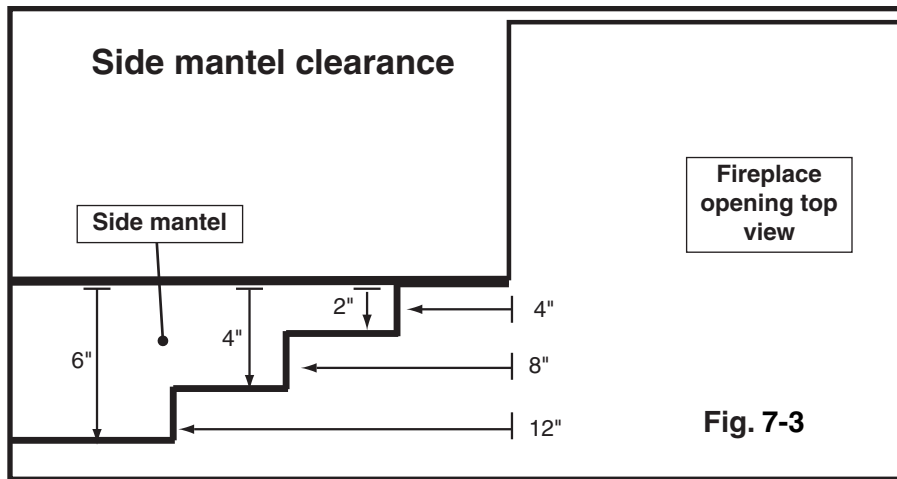
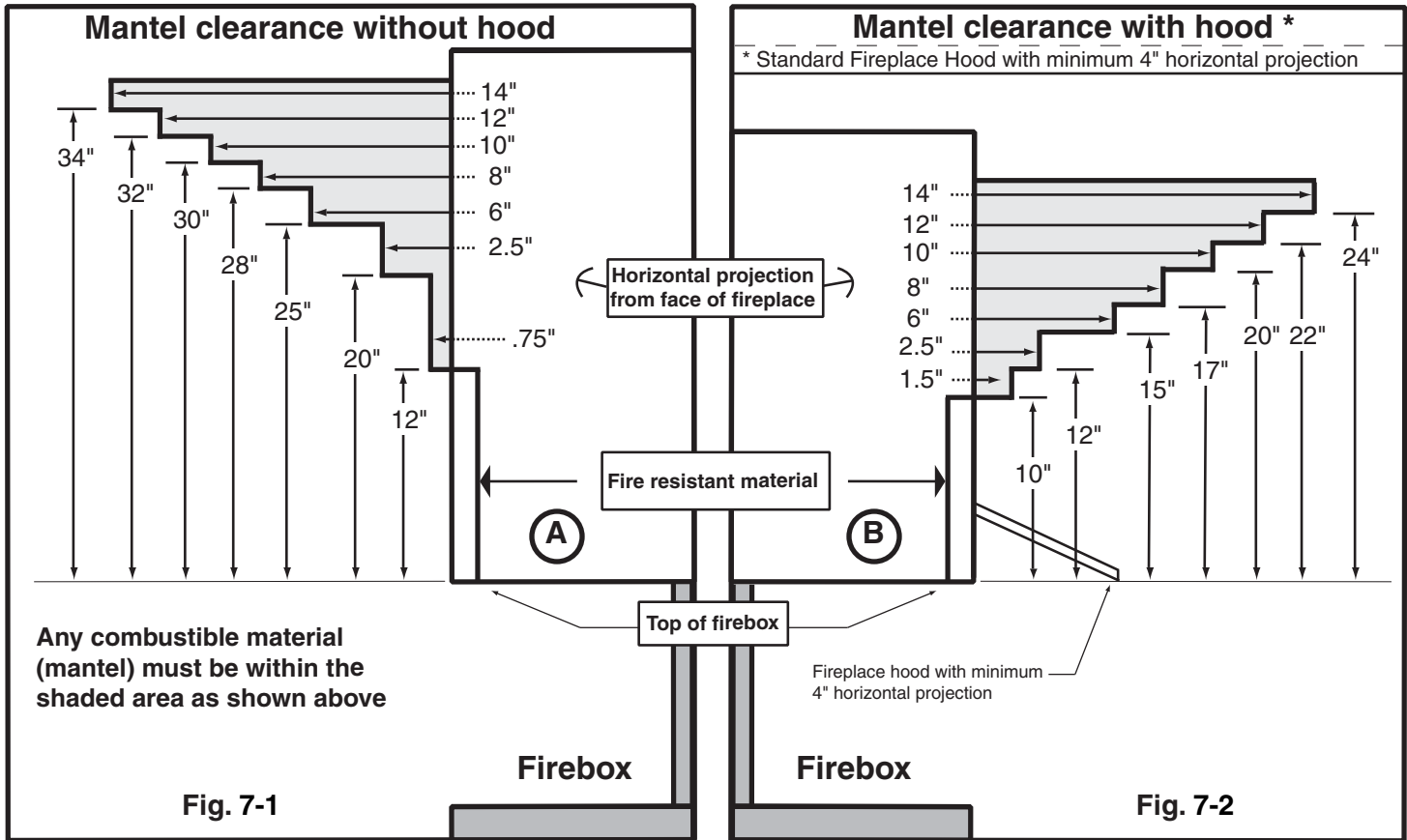

PRE-INSTALLATION AND FIREPLACE PREPARATION SAFETY

CAUTION: Installation and repair must be done by an NFI certified or other qualified professional installer.

Installer: Carefully read these instructions before installing this gas burner system. Be sure you understand all safety precautions and warnings contained in this manual.

PRE-INSTALLATION AND FIREPLACE PREPARATION SAFETY GUIDELINES

A. CAUTION: If not installed, serviced, and used correctly per these instructions, this product can cause serious personal injury, property damage, or loss of life.

B. WARNING: Before installing in a solid-fuel-burning fireplace, the chimney flue, damper, and firebox must be thoroughly CLEANED of soot, creosote, ashes, and loose paint by a qualified chimney cleaner. Some fireplaces (especially older ones) may need repair prior to installing this appliance.

C. This appliance is only for use with the type of gas indicated on the rating plate. This appliance is **NOT CONVERTIBLE** for use with other gasses.

CHECK GAS TYPE (natural or L.P.): The gas supply must be the same as stated on your burner system rating plate. If gas supply is different, **DO NOT INSTALL**. Contact your dealer for immediate assistance.

D. Any outside air ducts and/or ash dumps located on the floor or walls of the fireplace must be permanently sealed shut before the installation. Use a heat-resistant sealant. Do not seal the chimney flue damper.

E. INSUFFICIENT GAS PRESSURE WILL KEEP THE ODS (OXYGEN DEPLETION SENSOR) PILOT FROM OPERATING PROPERLY. DO NOT USE IF GAS PRESSURE IS LOWER THAN THE MINIMUM REQUIREMENT.

F. The *minimum* inlet gas-supply pressure for purposes of input adjustment is **5"** water column (w.c.) on **natural gas** and **11"** w.c. on **L.P. gas**. Insufficient gas pressure will affect proper operation of the ODS pilot. Do not install this gas appliance if minimum pressure is not available. The *maximum* inlet gas-supply pressure is **10.5"** w.c. on natural gas and **13"** w.c. on L.P. gas. The L.P. source must be regulated. **(Do not connect this appliance directly to an unregulated L.P. gas tank - this can cause an explosion.) Do not connect this appliance to a portable L.P. gas cylinder.**

G. **The gas piping system must be sized to provide minimum inlet pressure at the maximum flow rate (BTU/hr).** Undue pressure loss will occur if the pipe is too small, or the run is too long. Gas supply pipe must be 1/2" minimum interior diameter. If the gas line is longer than 20', a larger diameter line may be necessary. Refer to the NFPA 54 guidelines for further details.

H. The minimum clearance from the fireplace opening to combustible materials on side walls and ceiling must be maintained as outlined in MINIMUM CLEARANCE TO COMBUSTIBLES - WALLS AND CEILING.

I. At least 10"-12" of noncombustible or heat-resistant material is required above the fireplace. A fireplace hood will be required to act as a heat deflector in protecting combustible fireplace surrounds (facing and/or mantel) if certain minimum clearances cannot be met.

J. Be certain that combustible flooring material (i.e., carpet, tile, etc.) is not too close to this gas appliance. If this appliance is at floor level or less than 6" above the floor, there must be at least 12" of noncombustible material between the base of the fireplace and any combustible flooring.

K. Input ratings shown in BTU per hour are for elevations up to 2,000 ft. For elevations above 2,000 ft., refer to the National Fuel Gas Code or contact the Robert H. Peterson Company before installing this product.

L. This gas appliance and its main gas valve must be disconnected from the gas-supply piping system during any pressure testing of that system at test pressures in excess of 1/2 psig.

M. This gas appliance must be isolated from the gas-supply piping system by closing the equipment shutoff valve connected to the gas-supply line during any pressure testing of the gas-supply piping system at test pressures equal to or less than 1/2 psig.

N. Do not use this appliance if any part has been underwater. Immediately call a qualified professional service technician to inspect the appliance and to replace any part of the control system and any gas control that has been underwater.

WARNING

THIS APPLIANCE IS EQUIPPED FOR EITHER NATURAL OR PROPANE GAS.
FIELD CONVERSION IS NOT PERMITTED.

INSTALLATION SAFETY INFORMATION

INSTALLATION SAFETY GUIDELINES

- A. Carefully inspect the burner and log cartons for shipping damage. If any parts are missing/damaged, call your dealer. **Do not attempt** to install the appliance unless all parts are in good condition.
- B. Correct installation of the glass or the ceramic refractory log set and proper placement and installation of the burner assembly, including ember placement and Lava Granule placement, are imperative to safe operation of your set. Problems **WILL** occur if all items are not properly installed. Reference the INSTALLATION section, LOG PLACEMENT.
- C. When installing in a wood-burning fireplace, **center the appliance in the fireplace** while making certain that no part of the assembly protrudes (forward) beyond the face of the fireplace.
DO NOT PUSH THE UNIT ALL THE WAY TO THE BACK.
- D. If you use Lava Granules, or glass or gems, for decorative use, do not allow these accessories into or onto any part of the burner or on the logs. Lava Granules, or glass or gems used to accessorize the vent-free burner, should only be placed on the floor of the fireplace, in front of and to the sides of the burner, but away from the controls.
- E. **DO NOT PLACE** logs or other accessories, such as wood chips, pine cones, or vermiculite, on this appliance. These items will cause improper burning, sooting, and/or high levels of carbon monoxide. Additional logs and/or accessories may be placed around the burner system, as long as they do not interfere with the burning of your gas appliance.
- F. **Due to high temperatures, this appliance should be located out of traffic and away from furniture/ draperies.**
- G. A fireplace screen must be in place when this gas appliance is in operation. Unless other provisions for combustion air are provided, the screen shall have an opening(s) for introduction of combustion air.
- H. Connecting directly to an unregulated L.P. tank can cause an explosion.
- I. Special care is required if you are installing the unit into a **SUNKEN FIREPLACE**. You must raise the fireplace floor to allow access to gas controls. This will ensure adequate airflow and guard against sooting. Raise the fireplace floor using noncombustible materials.
- J. A vent-free room heater having an input rating of more than 10,000 BTU per hour shall not be installed in a bedroom (ANSI Z21.11.2).
If local codes allow, you may install a G8E-xxR burner, having a rating of 9,500 BTU, in a bedroom. An unvented room heater having an input rating of more than 6,000 BTU per hour shall not be installed in a bathroom (ANSI Z21.11.2).

Fireplace Floor Requirement

DO NOT install this burner system if the fireplace hearth is recessed. The fireplace floor must be at the same level as or larger than the fireplace front opening. An ash lip or recess may not exceed $\frac{3}{4}$ ". See Fig. 9-1 below.

Note: If glass doors are used: the fireplace floor must not be blocked by the door frame; the frame must have openings to allow for fresh air circulation.

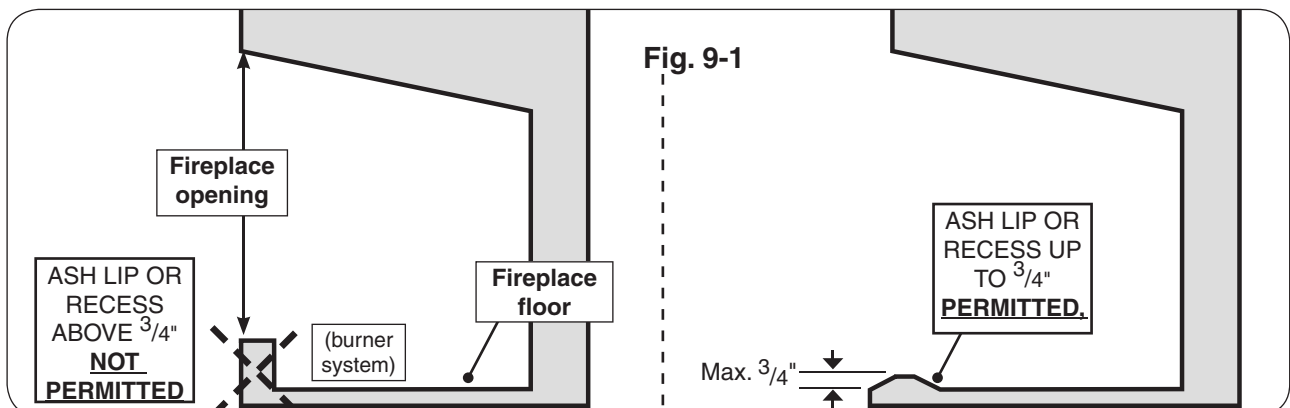

OPERATIONAL SAFETY INFORMATION

OPERATING YOUR UNVENTED GAS APPLIANCE SAFELY AND CORRECTLY

- A. SOLID FUEL MUST NOT BE BURNED** in a fireplace where this vent-free gas appliance is installed.
- B. GLASS DOORS MUST BE FULLY OPEN** when this vent-free gas appliance is operating. This appliance **MUST NOT BE ON** if glass doors are closed, as it can lead to sooting, burner outages, and possibly explosion, causing damage or injury.
- C. WARNING: DO NOT ALLOW DRAFTS INTO OR AROUND THE FIREPLACE. CLOSE (SHUT) HEATING AND AIR CONDITIONING VENTS, RETURNS, AND OUTSIDE AIR VENTS. DO NOT OPERATE FANS (WINDOW FANS, CEILING FANS, FLOOR FANS), WHICH MAY ALTER FLAME PATTERNS.** Sooting, excess carbon monoxide, or ODS pilot outages may occur due to drafts.
- D. WARNING: DO NOT USE A BLOWER INSERT, HEAT EXCHANGER INSERT,** or any other accessory that is not specifically certified for use with this vent-free gas appliance.
- E.** Make sure there is adequate combustion and ventilation air when this gas appliance is operating. You may need to crack the damper or open a window slightly.
- F. THIS APPLIANCE MUST BE MAINTAINED IN A WELL-CLEANED CONDITION AT ALL TIMES. REGULAR (AT LEAST ONCE PER YEAR) CLEANING OF THE BURNER AND ODS PILOT IS REQUIRED BY A QUALIFIED PROFESSIONAL SERVICE TECHNICIAN.**
- G.** To light this appliance, it may be necessary to purge the unit for longer than one minute after long periods of non-use.
- H.** If you operate this vent-free gas appliance fueled by L.P., operating characteristics may vary as the fuel in the tank approaches empty (**less than 1/4 full**). Sooting and other increases in combustion by-products will occur. Turn off the appliance, refill the L.P. tank, and have the burners cleaned.
- I.** During manufacturing, various parts of this unit are treated with oils or paints. Though not harmful, they may produce annoying smoke and smells as they are burned off during initial operation. This is a normal occurrence. Initial break-in period should last four to six hours; maximum ventilation should be provided by opening windows, doors, or chimney flue.
- J.** Keep the area around your gas appliance clear of combustible materials, gasoline, and any other flammable vapors/liquids. Provide adequate clearance for servicing and operation. Be especially cautious if this gas appliance is installed in a basement or converted garage.
- K.** Do not place clothing or any flammable material on or near your vent-free gas appliance. Matches, paper, garbage, or any other material must not be thrown on top of the logs, burner, or into the flame.
- L. Young children should be carefully supervised when in the same room with this appliance.**
- M.** Children and adults should be alerted to the hazard of high surface temperatures and should stay away to avoid burns or clothing ignition.

OPERATIONAL SAFETY INFORMATION (Cont.)

OPERATING YOUR UNVENTED GAS APPLIANCE SAFELY AND CORRECTLY

- N. This appliance is intended for supplemental heating, and is not a primary heating source.** Water vapor produced by vent-free burner systems can create moisture problems in a home when operated for extended periods of time. If condensation begins to occur, open your damper or a window.
- O.** If the gas quality is poor or pressure low, your ODS pilot may not stay lit, the burners may produce soot, or the unit may backfire. Contact your local gas supplier immediately.
- P.** This appliance is designed for adults to be present while in operation. Do not leave this unit burning when unattended or while sleeping. **This is an attended appliance.**
- Q.** WARNING: Failure to keep the primary air opening(s) of the burner(s) clean may result in sooting and property damage.
- R.** WARNING: All previously applied loose material, such as embers, must be removed prior to reapplication. All replacement loose material must be purchased from the original appliance manufacturer.
- S.** Unusually tight construction is defined as:
 - a.** Walls and ceilings exposed to the outside atmosphere have a continuous water vapor retarder with a rating of 1 perm (6×10^{11} kg per pa-sec- m^2) or less with openings that are sealed or use gaskets;
 - b.** Weather stripping has been added on openable windows and doors; AND
 - c.** Caulking or sealants are applied to areas such as joints around window and door frames; between sole plates and floors; between wall-ceiling joints; between wall panels; at penetrations for plumbing, electrical, and gas lines; and at other openings.
- T.** Burning candles, air fresheners and sprays will cause objectionable odors to be created by the unvented burner system.

CLEANING AND SERVICING IMPORTANT INFORMATION

It is imperative that you maintain your unvented gas appliance by having it cleaned and serviced regularly. A qualified professional service technician shall inspect and service this unit at least annually. (Read and follow the CLEANING AND SERVICING sections for details.)

Failure to provide reasonable and necessary maintenance as outlined in the owner's manual will cause your appliance to malfunction and will void your warranty.

BURNER PARTS LIST

To order replacement parts, contact your local dealer.

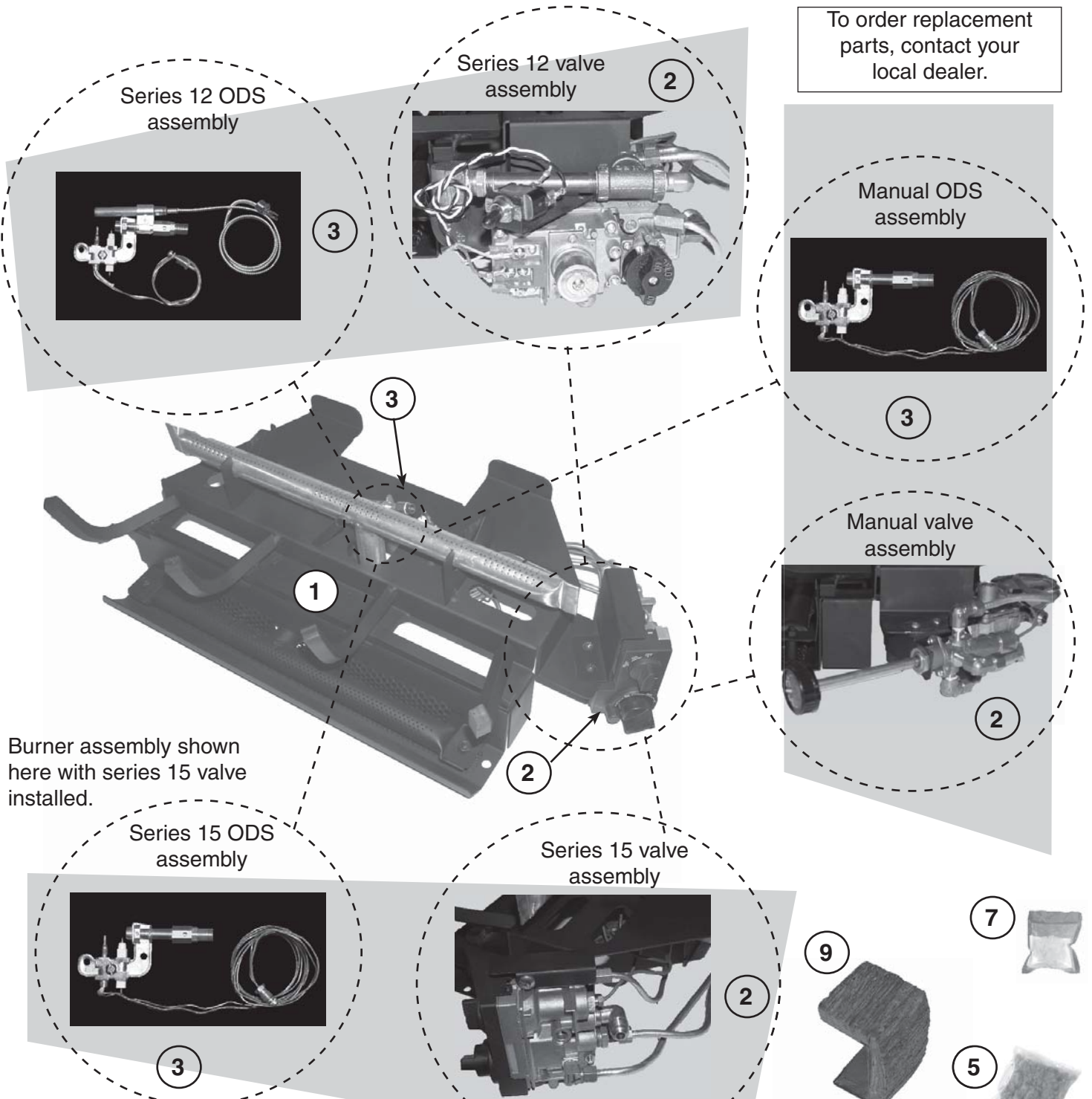

Burner assembly shown here with series 15 valve installed.

Item	Description
1.	Burner assembly
2.	Valve assembly (natural or propane)
3.	ODS pilot (natural or propane)
4.	Connector kit
5.	Glowing embers
6.	Lava granules
7.	Bryte coals
8.	Remote kit (if equipped)
9.	Decorative heat shield (if equipped)



LOGS PARTS LIST

Log sets are purchased and packaged separately. Styles and sizes will vary depending upon the log set ordered.

WARNING: Failure to position these parts in accordance with these instructions, or failure to use only parts specifically approved with this unvented gas log set, may result in property damage or personal injury.

Split Oak
S9-(20,24,30)

Golden Oak Designer
RD9-(20,24,30)

Forest Oak
FO9-(20,24,30)

RD9-24 shown

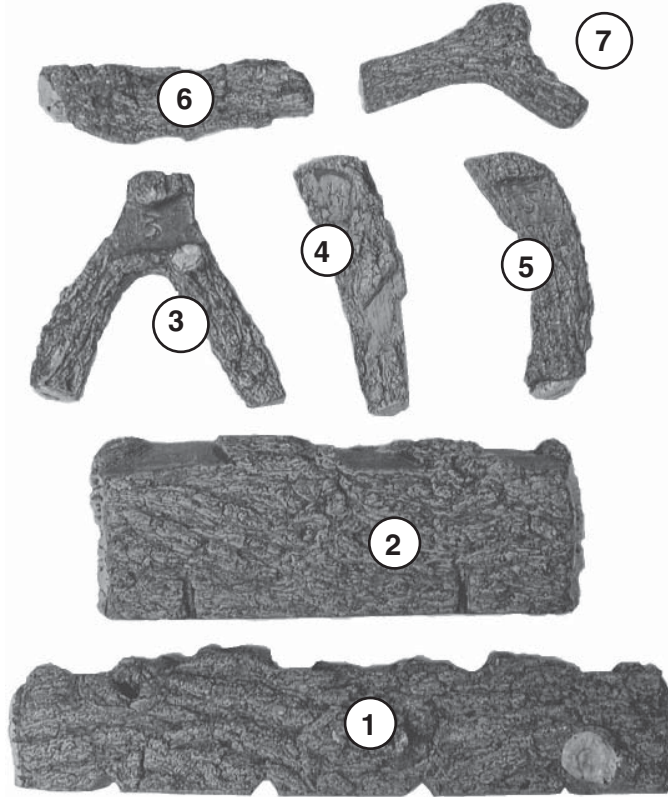

Replacement parts can be ordered from your local Real Fyre dealer.

Description	20" set		24" set		30" set	
	Part No.	Qty.	Part No.	Qty.	Part No.	Qty.
1. Bottom front log - RD9 or Bottom front log - FO9 or Bottom front log - S9	RDL9-20BF FOL9-20BF SL9-20BF	1 1 1	RDL9-24BF FOL9-24BF SL9-24BF	1 1 1	RDL9-30BF FOL9-30BF SL9-30BF	1 1 1
2. Bottom rear log - RD9 or Bottom rear log - FO9 or Bottom rear log - S9	RDL9-17BR FOL9-17BR SL9-17BR	1 1 1	RDL9-17BR FOL9-17BR SL9-17BR	1 1 1	RDL9-20BR FOL9-20BR SL9-20BR	1 1 1
3. Middle left log - RD9 or Middle left log - FO9 or Middle left log - S9	RDL9-10TY FOL9-10TY SL9-10TY	1 1 1	RDL9-10TY FOL9-10TY SL9-10TY	1 1 1	RDL9-10TY FOL9-10TY SL9-10TY	1 1 1
4. Middle center log - RD9 or Middle center log - FO9 or Middle center log - S9	RDL9-10TC FOL9-10TC SL9-10TC	1 1 1	RDL9-10TC FOL9-10TC SL9-10TC	1 1 1	RDL9-10TC FOL9-10TC SL9-10TC	1 1 1
5. Middle right log - RD9 or Middle right log - FO9 or Middle right log - S9	RDL9-10TR FOL9-10TR SL9-10TR	1 1 1	RDL9-10TR FOL9-10TR SL9-10TR	1 1 1	RDL9-10TR FOL9-10TR SL9-10TR	1 1 1
6. Top left log - RD9 or Top left log - FO9 or Top left log - S9	RDL9-11TL FOL9-11T SL9-11T	1 1 1	RDL9-11TL FOL9-11T SL9-11T	1 1 1	RDL9-11TL FOL9-11T SL9-11T	1 1 1
7. Top right log - RD9 or Top right log - FO9 or Top right log - S9	RDL9-9TY FOL9-9TY SL9-9TY	1 1 1	RDL9-9TY FOL9-9TY SL9-9TY	1 1 1	RDL9-9TY FOL9-9TY SL9-9TY	1 1 1

WHEN USED AS A VENTED DECORATIVE APPLIANCE (PER ANSI Z21.60)

This appliance is for installation in a solid-fuel burning fireplace (masonry fireplace or manufactured fireplace) with a working flue and constructed of noncombustible material.

These gas logs may be installed as vented decorative log sets in compliance with ANSI Z21.60 and National Fuel Gas Code, Section 6.6. The minimum permanent free opening of the fireplace chimney or chimney damper must be met per the Chimney Vent Opening Table on pg 3 of this manual. Chimney damper must be fixed in a manner to maintain permanent free opening at all times. To accomplish this, install a screw or bolt in the edge of the damper to prevent closing, or drill holes in the damper or remove the damper.

INSTALLATION

BEFORE PROCEEDING, CAREFULLY READ ALL OF THE IMPORTANT SAFETY INFORMATION CONTAINED IN THIS OWNER'S MANUAL, INCLUDING:

- A. Pre-Installation and Fireplace Preparation Safety Guidelines
- B. Ventilation and Confined Space Information
- C. Installation Safety Guidelines

I M P O R T A N T

Be sure you have read and understand all safety precautions and warnings contained in this manual.

Note: To install your Real Fyre vent-free gas log set, your fireplace must have a gas supply line that has been installed by a qualified professional technician in accordance with all local codes. Refer to the PARTS LIST when installing the vent-free gas log set.

Tools Required:

- | | |
|--|--|
| 1. Adjustable open-ended wrench | 4. Soapy water solution & brush for leak detection |
| 2. Pliers | 5. Flathead screwdriver |
| 3. L.P. gas resistant pipe compound or Teflon tape | 6. Manometer (recommended for checking gas pressure) |

CHECK GAS TYPE (natural or L.P.). The gas supply must be the same as stated on your gas log set rating plate. **If the gas supply is different, DO NOT INSTALL.** Contact your dealer for immediate assistance.

W A R N I N G

Do not connect this appliance directly to a high pressure natural gas line or an unregulated L.P. gas tank.

WARNING: Failure to position these parts in accordance with these diagrams or failure to use only parts specifically approved with this unvented burner system may result in property damage or personal injury.

INSTALLATION (Cont.)

INSTALL BURNER

REFER TO THE BURNER PARTS LIST WHEN FOLLOWING THESE INSTRUCTIONS.

1. MAKE SURE THE FIREPLACE GAS SUPPLY IS TURNED OFF.
2. Locate the gas-supply stub inside the fireplace and remove the cap, if attached.

CAUTION: When removing the cap, make sure the stub does not turn, loosening the connection inside the wall.

3. Place the burner system in the fireplace. Center the burner in the fireplace.
4. **Be sure gas to the fireplace is off.** Remove the adapter connected to the flex connector (pre-installed on the burner system). Attach the adapter to the gas-supply stub using a pipe compound resistant to all gasses. Tighten securely. Then attach the open end of the flex connector to the adapter. Tighten securely.
5. **LEAK TEST:** Turn on the fireplace gas supply, and test at all connections for leaks using the appropriate soapy water solution. If bubbles appear, a leak is present. Turn off the gas and tighten at all connections. Repeat until no leaks are present. If a leak persists, turn off the gas supply and contact the local gas company or dealer. **NEVER USE A FLAME TO CHECK FOR LEAKS.**

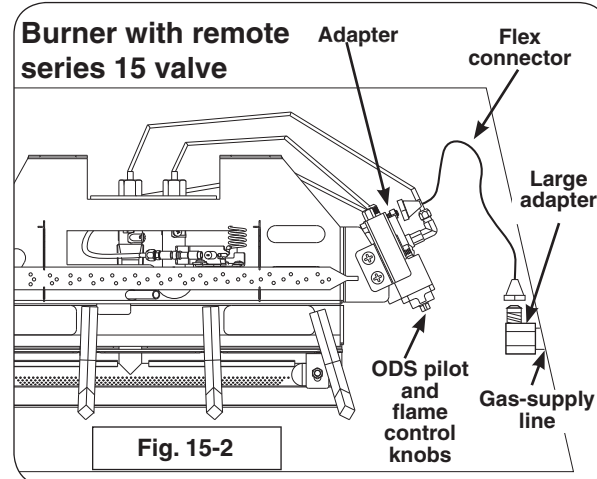
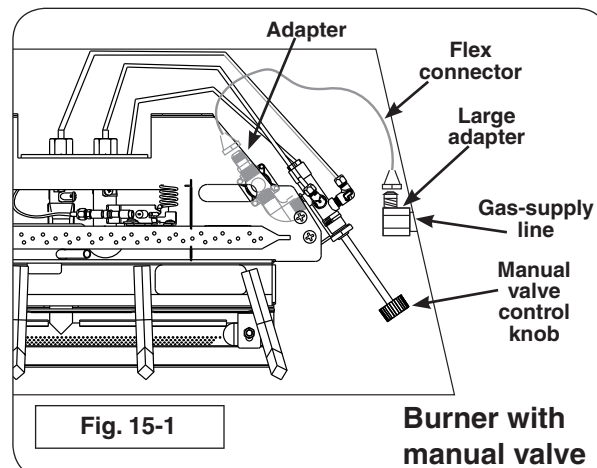

REMOTE SYSTEM (if equipped)

If the unit is equipped with a remote; read and follow the separate instructions (packed with the remote) for complete remote installation.

SECURE BURNER TO FLOOR

Two holes exist on the base of the burner assembly for securing it to the fireplace floor in a mobile home, or if required by the installation or inspector. Using the appropriate hardware for your fireplace construction (not included); secure the burner system into the fireplace floor (see Fig. 15-4).

Note: If you have a manufactured fireplace, check with the manufacturer before drilling holes in the floor.

LIGHTING TEST

Prior to proceeding with installation, perform a lighting test (see lighting instructions for lighting your burner).

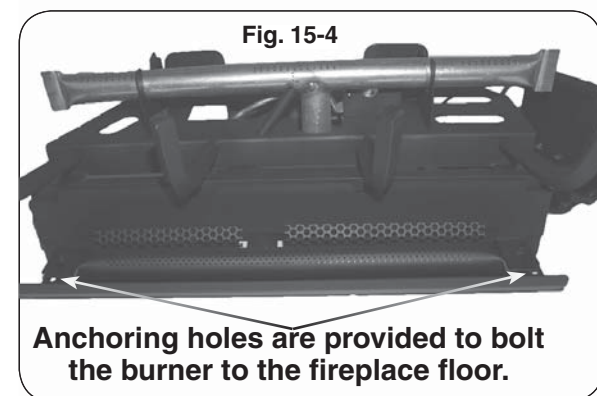
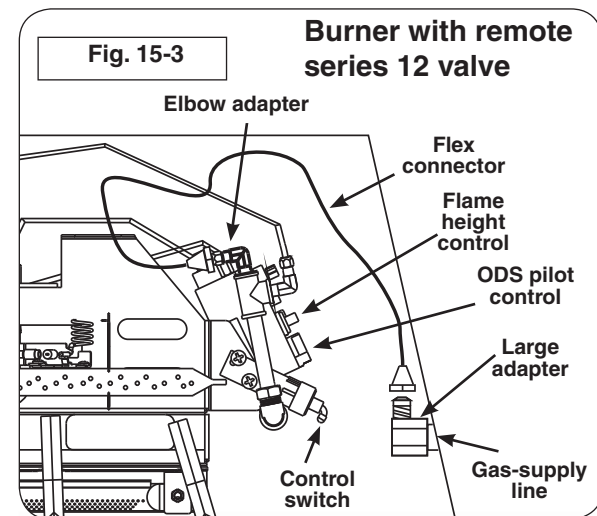

INSTALLATION (Cont.)

CHECKING GAS PRESSURE

WARNING: Do not connect this appliance directly to a high-pressure natural gas line or an unregulated L.P. tank.

Test all gas joints from the gas meter to the valve assembly for leaks using a half-and-half soapy water solution after completing connection. **DO NOT USE AN OPEN FLAME FOR CHECKING GAS LEAKS.**

Important: Check the gas pressure with the unvented gas log set burning and the control set to **HIGH**.

The gas log set and its main gas valve must be disconnected from the gas-supply piping system during any pressure testing of that system at test pressures in excess of 1/2 psig. The gas log set must be isolated from the gas-supply piping system by closing its equipment shutoff valve during any pressure testing of the gas-supply piping system at test pressures equal to or less than 1/2 psig. This is accomplished by closing the gas-supply line valve.

Manual Safety ODS Pilot Valve (Fig. 16-1)

The pressure regulator is preset at the factory and sealed to discourage tampering. If the pressure is not as specified, replace the regulator with the correct part from the PARTS LIST in this manual.

Remove the 1/8" pressure tap screw plug, located on the side of the regulator body. Install fitting and tubing of pressure gauge. With the unit operating, take the pressure reading. Reinstall the pressure tap screw and check for leaks.

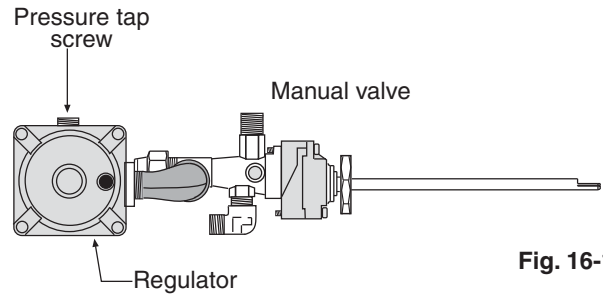

Fig. 16-1

Millivolt Safety ODS Pilot Valve (Fig. 16-2)

The valve regulator controls the burner pressure. To take a pressure reading, turn the *inlet* or *outlet* screw two to three turns. Place the pressure gauge tubing over the pressure inlet point. Turn the unit on and to the **HIGH** position to get the reading. Tighten the screws and repeat with the other pressure inlet point. When finished, check both inlet points for leaks.

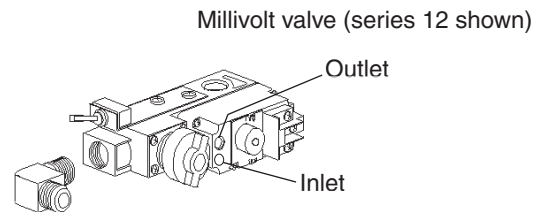

Fig. 16-2

GAS PRESSURE SPECIFICATIONS

NATURAL GAS

MANUAL PRESSURE		MILLIVOLT PRESSURE	
Regulator pressure reading:	3.5" w.c.	Outlet pressure reading: (Flame adjustment on high)	3.5" w.c.
Gas inlet pressure:	Max. 10.5" w.c. Min. 5" w.c.	Inlet pressure reading:	Max. 10.5" w.c. Min. 5" w.c.

L.P. GAS

MANUAL PRESSURE		MILLIVOLT PRESSURE	
Regulator pressure reading:	10" w.c.	Outlet pressure reading: (Flame adjustment on high)	10" w.c.
Gas inlet pressure:	Max. 13" w.c. Min. 10" w.c.	Inlet pressure reading:	Max. 13" w.c. Min. 10" w.c.

Important: For all valves, the air MUST be purged from the gas line before the ODS pilot will light properly. The time taken to do this will depend on the length of gas line from the meter to the unit and the length of time since the unit or gas line was last used (in the case of non-use during warm weather, for example). It may take from 3 to 15 minutes before all the air is purged and the ODS pilot will light properly. This is done using the method for lighting the ODS pilot, but holding in the control valve for a longer period. Follow the LIGHTING INSTRUCTIONS in this manual for the specific valve type.

INSTALLATION (Cont.)

LOG PLACEMENT

WARNING: Failure to position the parts in accordance with these instructions and diagrams, or failure to use only Peterson Real Fyre controls, parts, and accessories that have been specifically listed or certified for use with this heater, may result in property damage or personal injury.

Fig. 17-1

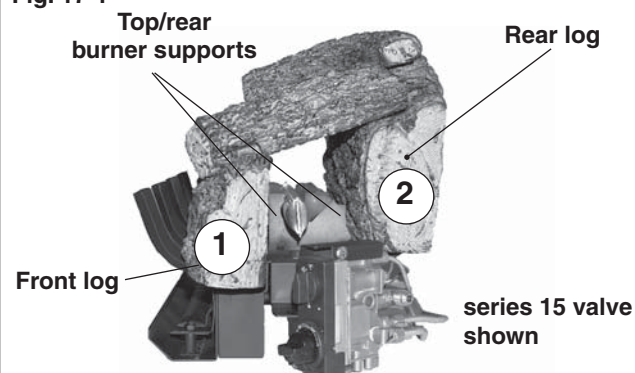

Fig. 17-2

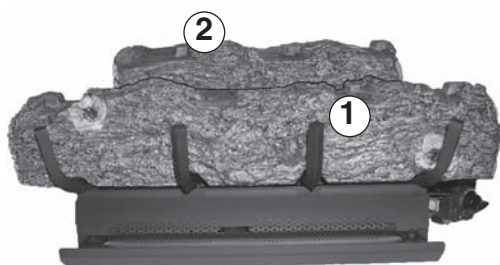

Fig. 17-3

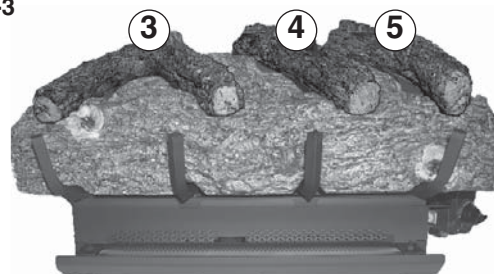
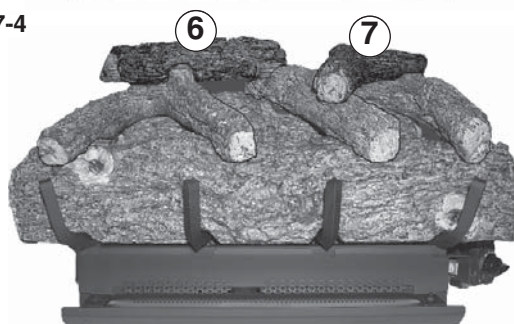

Fig. 17-4



Showing the finished Golden Oak Designer (RD9) above. The Split Oak (S9) and Forest Oak (FO9) set will have an identical log setup and positioning.

Important: Carefully follow the detailed instructions below and on the next page for correct log placement.

Log placement is critical to ensure proper performance of the gas log set. Be sure to follow the log placement instructions carefully. Logs are placed the same way for all sizes of log sets.

1. Each log in the unvented gas log set is numbered to aid in the log placement procedures. Set the front log (Log #1) and rear log (Log #2) in their approximate positions on the grate (as shown in Fig. 17-1). The rear burner supports assist in the positioning of logs #1 and #2.
2. Position the front log (Log #1) so that the rear burner supports fit tight against the back of the log (Fig. 17-1). Ensure the grooves in the bottom of the log sit on the grate fingers.
3. Center the rear log (Log #2, left to right) and pull forward so the slots in the front of this log are against the rear burner supports (Figs. 17-1, 17-2).
4. Position the middle logs (Logs #3, #4, and #5) on top of the bottom logs. Place the logs so that each log rests in the corresponding slots on the bottom front log and bottom rear log (see Fig. 17-3).
5. Position the two top logs (Logs #6 and #7) on the top of the intermediate logs. Position the top logs by placing each top log into the slots of the intermediate logs (see Fig. 17-4).

INSTALLATION (Cont.)

CAUTION: Burn hazard. Logs will remain hot for some time after use. You must maintain the log layout as shown to ensure proper operation of the log set. If you need to reposition any log to maintain the proper layout, use heat-resistant gloves or allow logs adequate time to cool before handling.

After setting the logs into position as described on the previous page, ensure each is properly and firmly seated. This unvented gas log set will not function as intended if the logs are not correctly positioned. When placed properly, the flames will not strike any portion of Logs #3, #4, #5, #6, or #7. Periodically check the positioning of all logs to ensure proper log placement and stability. If any flame is striking Logs #3, #4, #5, #6, or #7, recheck log placement. Adjust to conform with instructions. **There must be no flame impingement on these logs.**

GLOWING EMBER PLACEMENT

The Glowing Embers are supplied in a single bag (Fig. 18-1). It is important that the embers be used in the designated application and that no additional embers be added. **Open the bag and spread the embers loosely along the entire length of the ember burner (Fig. 18-3). Break up any clumps that may have developed during shipment, and make sure the embers are spread evenly over the entire area.** Bryte Coals are placed over the glowing embers, also spreading out evenly (Figs. 18-2, 18-3). Failure to follow these instructions will result in unsafe operation.

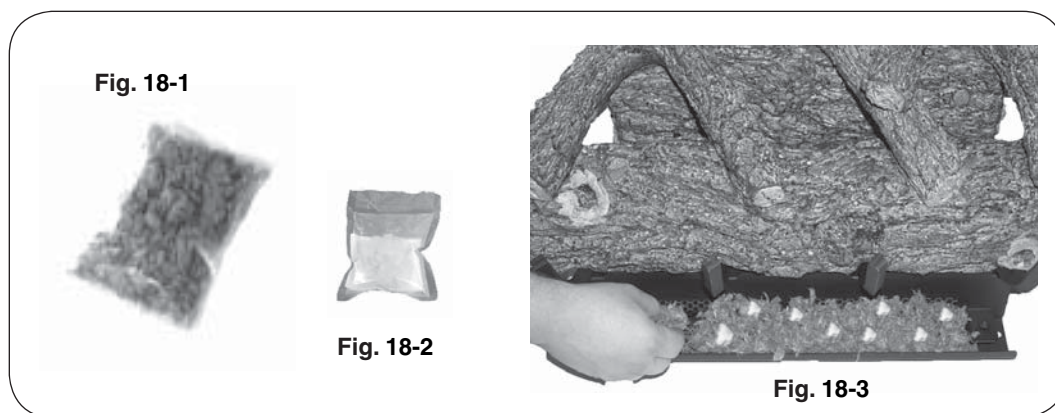

Important: Do not add any additional embers or Bryte Coals to this log set. Any additional embers may cause unsafe operation.

LAVA GRANULES PLACEMENT

Lava Granules are provided as an aesthetic enhancement to the unvented gas log set and do not affect its operation. Spread the Lava Granules on the floor of the firebox around the front and the sides of the unvented gas log set. **BE SURE THAT NO LAVA GRANULES ENTER THE BURNER SYSTEM OR INTERFERE WITH THE BURNING OF THE LOG SET.**

INSTALLATION (Cont.)

IMPORTANT

For all valves, the air MUST be purged from the gas line before the pilot will light properly. The time taken to do this will depend on the length of gas line from the meter to the unit and the length of time since the unit or gas line was last used (in the case of non-use during warm weather, for example). It may take from 3 to 15 minutes before all the air is purged and the pilot will light properly. This is done using different methods, depending on which valve is fitted to the unit. Follow the LIGHTING INSTRUCTIONS in this manual for the specific valve type.

- A. Manual series - Hold down control knob at **PILOT** (see Fig. 19-1).
- B. 15 series - Hold in control knob at **PILOT** (see Fig. 19-2).
- C. 12 series - Hold in control knob at **PILOT** (see Fig. 19-3).

CONTROL SETTINGS

We recommend that before you install the log set, you familiarize yourself with the control valve layout. This will help you to be confident operating the log set when fully installed. See the figures below for typical control positions.

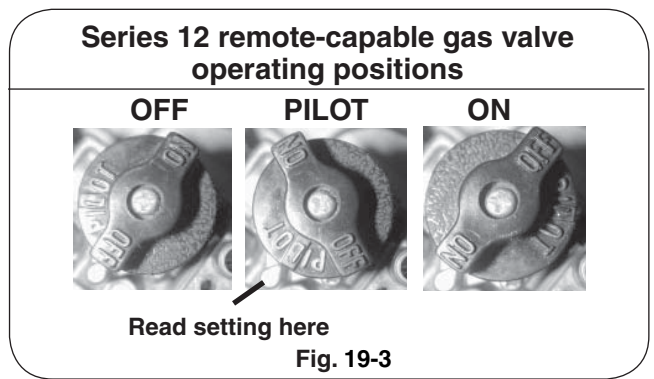
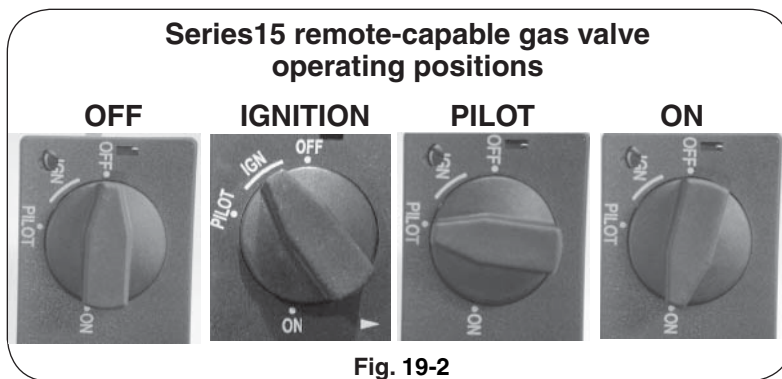
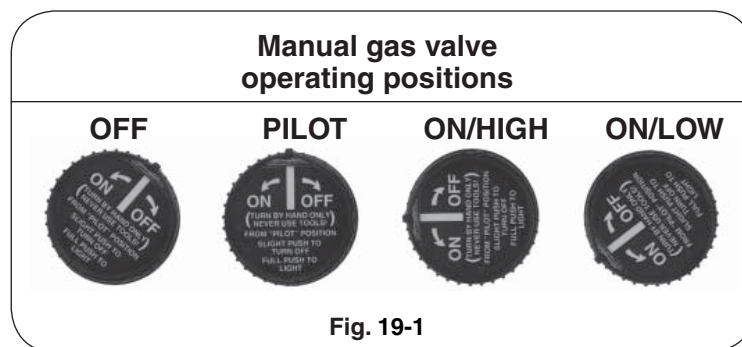

DAMPER CLAMP INSTRUCTIONS (IF APPLICABLE)

If the burner system is installed as a vented decorative appliance:

The damper clamp with hex bolt (Fig. 19-4) is provided as a means to prevent full closure of the damper blade. The clamp is easily attached to most damper blades with pliers or a wrench, and must be permanently installed. The clamp is designed to prevent accidental closure of the damper when installed as illustrated (Fig. 19-5 and Fig. 19-6). Should the clamp not fit, or fail to provide the permanent vent opening specified in Table 3-1, have a permanent stop installed, remove the damper blade, or have the damper cut to provide the minimum permanent opening required.

The damper clamp is not required if the burner system is installed as an unvented room heater.

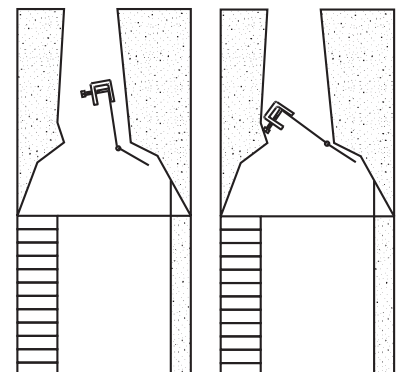
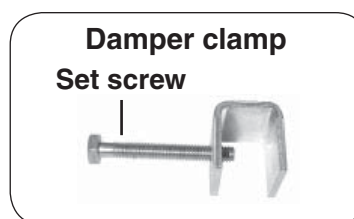

Fig. 19-5

Fig. 19-6

CLEANING AND SERVICING SAFETY INFORMATION

Note: Regular cleaning and servicing will be necessary to ensure proper ODS pilot operation and proper burn characteristics.

- A. Always shut off the gas to the unvented gas log set while performing service work.
- B. Allow the unvented gas log set to cool before servicing.
- C. **Installation, service, and repair must be done by an NFI Certified or other qualified professional service technician. The appliance MUST be inspected before use, and cleaned at least annually to prevent burner shutdown, sooting, odors, etc. by a qualified professional service technician. It must be checked for clean burning operation and proper ODS pilot appearance, with the correct tools to service this unit. More frequent cleaning may be required.** Excessive lint can build up on this unit from carpeting, bedding material, pet hairs, or other particles in the air. It is imperative that all control components and compartments, burner(s), and circulating air passageways of the appliance be kept clean and free of all obstructions. The ODS pilot is especially sensitive to a dirty environment and will not function properly if dirty. Make certain all air openings are clean and free of obstructions, including:
 - 1. The air intake opening on the ODS pilot assembly.
 - 2. The ODS pilot opening.
 - 3. The air shutters on both the front/bottom ember burner and the rear/top main burner.
 - 4. The flash tube and its corresponding carryover port. Obstructions in or around the flash tube may result in the ember burner not lighting and/or an intermittent popping noise from the flash tube.

WARNING: Failure to keep the primary air openings of the burner(s) clean may result in sooting and property damage.

- 5. All of the ports on both the front/bottom ember burner and the rear/top main burner. (See the CLEANING AND SERVICING section.)
- D. **Any safety screen or guard removed for servicing must be replaced prior to operating this gas log set.**

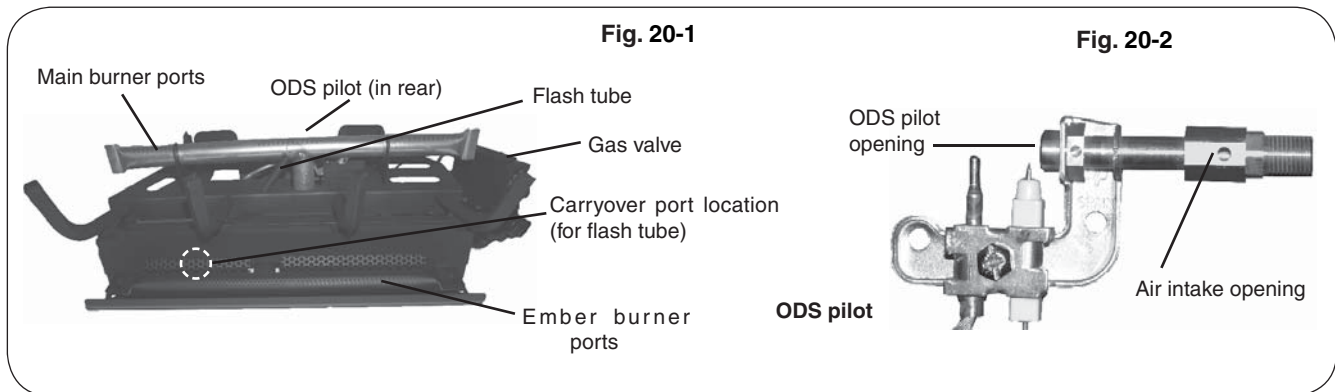

CLEANING AND SERVICING

Only limited cleaning will be required under normal use of the unvented gas log set.

TO CLEAN THE LOG SET

1. Remove the log set and embers. Use a vacuum cleaner to remove loose particles from all surfaces of the log set. Do not use cleaning fluids.
2. Dust the grate, the assembly, and the burners. Using a compressed air duster (commonly available at computer, electronic, or office supply stores); blow through the flash tube, its corresponding carry over port, and all of the burner ports. See Fig. 19-1 on the previous page for locations.
3. Reinstall the log set and embers as instructed in this manual.

If, after a period of use, the flames start to exhibit unusual shapes and behavior, or the burners fail to ignite smoothly, the burner ports may require some cleaning. If this happens, it is preferable to contact the nearest dealer to get the unvented gas log set serviced.

Do not remove the rating plates or the warning tags. These are an integral safety and identification component of this appliance.

During periods of heavy use, inspect the unvented gas log set frequently for evidence of sooting. If sooting is present, discontinue use until the source of sooting is corrected.

CLEANING AND SERVICING THE ODS PILOT

Periodic cleaning and maintenance of the unvented gas log set is recommended to ensure that the log set operates properly. Cleaning of the ODS pilot system is an important part of the maintenance program.

This ODS pilot cleaning procedure must be performed by a qualified professional service technician familiar with the specific characteristics of the log set.

1. Turn the unvented gas log set to the **OFF** position and allow it to cool. Inspect the ODS pilot area (see Fig. 21-1) for any visual contamination or debris (usually lint, hair, spider webs, or small insects). Lightly brush off all external surfaces while vacuuming loosened debris from the ODS pilot opening. **Be careful not to brush any foreign material into the ODS pilot opening.**
2. Clean out the air intake opening (see Fig. 21-1) by lightly brushing around the opening while vacuuming.
Note: It is very important that the air intake opening be kept clear of debris. Should the opening become blocked, the ODS pilot system will not operate properly.
3. Light the ODS pilot according to the relevant LIGHTING INSTRUCTIONS page. Periodically verify the ODS pilot flame appears as shown in the CHECKING THE ODS PILOT FLAME APPEARANCE section.
4. If the ODS pilot flame does not burn as indicated in the instructions, extinguish the ODS pilot by turning the valve to the full **OFF** position. Using a compressed air duster, insert the flexible nozzle through the air intake opening, ensuring that the nozzle is pointed toward the ODS pilot opening (see Fig. 21-1). Blow air through the air intake opening to clear out any debris that may be in the system.
5. Relight the ODS pilot and inspect it to be sure it is burning as shown in the instructions. If not, extinguish the ODS pilot and **turn off the gas supply to the gas log set.** Using an adjustable or a 1/4" wrench, disconnect the ODS pilot gas line (see Fig. 21-1) from the valve.
6. Insert the flexible nozzle of the compressed air duster and blow air into the input end of the ODS pilot gas line to remove any blockages. **Do not blow air directly into the ODS pilot opening. Blow air in the direction of the gas flow.**
7. Reinstall the ODS pilot gas line and check for leaks.
8. Light the ODS pilot to make sure it is operating properly (see LIGHTING INSTRUCTIONS).
9. If the ODS pilot still does not operate properly, the ODS pilot may need to be replaced with the same model as the one on the unvented burner.

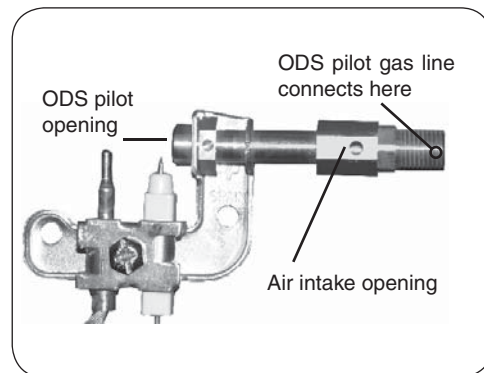

Fig. 21-1

OPERATING THE UNVENTED GAS LOG SET

Observe the flames. The main burner flames should be blue at the base and a combination of blue/yellow at the body and at the tips. They should be 5" to 8" above the logs, with the center flame being the tallest (see Fig. 22-1). Front flames in the ember burner should be 1/4" above the embers.

Every Real Fyre unvented gas log set leaves the factory tested and quality checked to ensure that it has been manufactured to the strict specifications to which it was submitted and approved for certification. This check includes an operational test to ensure both satisfactory combustion and operation.

Each installation site for any unvented appliance presents its own unique combustion environment. Specific factors such as weather-tightness of the home, size of the room in which the log set is installed, central heating, ceiling fans, altitude, drafts, pet hair, carpet lint, dryer lint, the size of the fireplace, paint or soot inside the fireplace, etc. all have an influence on the proper operation of an unvented appliance and its ODS pilot system. A normally operating unvented log set will demonstrate the following characteristics:

- A lively, realistic flame and front ember glow. The flame will be blue/yellow on the front burner and on the rear burner.
- Clean-burning combustion that will produce no soot or smoke after normal break-in.
- Production of no odor, other than normal odors associated with the combustion of L.P. or natural gas.
- Production of water vapor. Water vapor helps to increase indoor humidity, which may be beneficial during the dry heating season.

If you operate the unvented gas log set fueled by L.P. gas, operating characteristics may vary as the fuel in the tank approaches empty (less than 1/4 full). Sooting and other increases in combustion by-products will occur. Turn off the log set and refill the L.P. tank.



Front view with burners on

Fig. 22-1

CHECKING THE ODS PILOT FLAME APPEARANCE

When installing the burner assembly, it is important to visually check the ODS pilot flame and the burner flames.

1. The ODS pilot flame must be present when the burner is operating. The flame should touch the top of the thermocouple tip (Fig. 22-2 and Fig. 22-4).
2. If the ODS pilot flame does not touch the top of the thermocouple tip, then the main burner will not function properly (see Fig. 22-3 and Fig. 22-5 for incorrect ODS pilot flame).
3. With the burners off and the ODS pilot flame off, and the assembly cool, check the burner assembly, air intake openings on the ODS pilot, and air shutter openings on the burner for any blockages that could affect the operation of the ODS pilot flame.

ODS Pilot for Manual and series 15 valves

(NG shown)

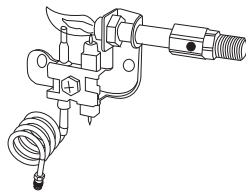

Correct ODS pilot flame

Fig. 22-2

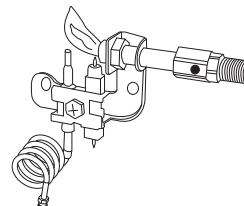

Incorrect ODS pilot flame

Fig. 22-3

ODS Pilot for series 12 valve

(NG shown)

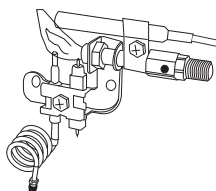

Correct ODS pilot flame

Fig. 22-4

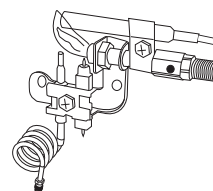

Incorrect ODS pilot flame

Fig. 22-5

LIGHTING INSTRUCTIONS - SERIES 12 VALVE

FOR YOUR SAFETY, READ BEFORE LIGHTING

WARNING: If you do not follow these instructions exactly a fire or explosion may result, causing property damage, personal injury, or loss of life.

The Real Fyre gas log set has an ODS pilot that must be lit by hand. When lighting the ODS pilot, follow these instructions exactly.

A. BEFORE LIGHTING, smell all around the gas log set area for gas. Be sure to smell next to the floor, because some gas is heavier than air and will settle on the floor.

B. WHAT TO DO IF YOU SMELL GAS

- Open a window.
- Do not try to light the appliance.
- Do not touch any electrical switch; do not use any phone in your building.
- Immediately call your gas supplier from a neighbor's phone. Follow the gas supplier's instructions.

- If you cannot reach your gas supplier, call the fire department.
- C. Use only your hand to push in or turn the gas control knob. Never use tools. If the knob will not push in or turn by hand, don't try to repair it. Call a qualified professional service technician. Force or attempted repair may result in fire or explosion.
- D. Do not use the gas log set if any part has been submerged in water. Immediately call a qualified professional service technician to inspect the gas log set and to replace any part of the control system and any gas control that has been underwater.

LIGHTING INSTRUCTIONS FOR YOUR MILLIVOLT GAS VALVE SYSTEM

1. **STOP! READ THE SAFETY INFORMATION CONTAINED IN THIS MANUAL ON P. 1.**
2. Turn the control switch, wall switch, or remote switch to the **OFF** position, or set the thermostat in the lowest possible setting.
3. Push in the control knob (Fig. 23-1) and turn clockwise ↻ to the **OFF** position.
4. Smell for gas, especially near the floor. If you smell gas, **STOP!** Follow B in the safety information on this page. If you don't smell gas, go to the next step.
5. Push and turn control knob counterclockwise ↶ to **PILOT**.
6. Push in on the control knob **all the way** and hold in. Immediately light the ODS pilot or press in ignitor button (Fig. 23-2) to light ODS pilot. Continue to hold the control knob in for approximately 30 seconds after the ODS pilot is lit. Release the knob, and it will pop back out. The ODS pilot should remain lit. If it goes out, repeat steps 5 through 6.
 - **If knob does not pop up when released, stop and immediately call your service technician or gas supplier.**
 - If the ODS pilot will not stay lit after several tries, follow the instructions TO TURN OFF GAS TO APPLIANCE in your Owner's Manual and call your service technician or gas supplier.
7. Push and turn the gas control knob counterclockwise ↶ to the **ON** position.

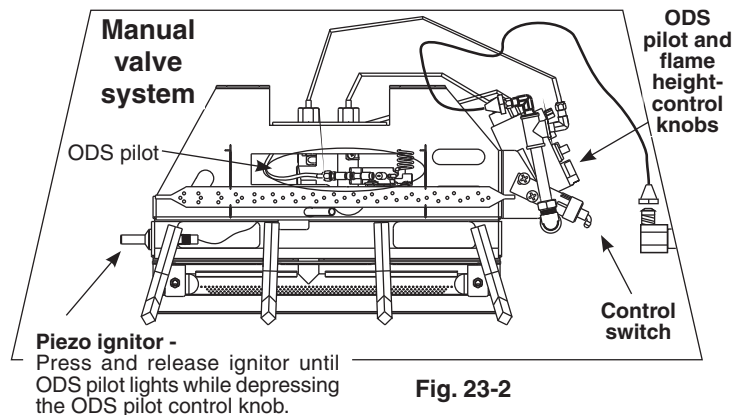
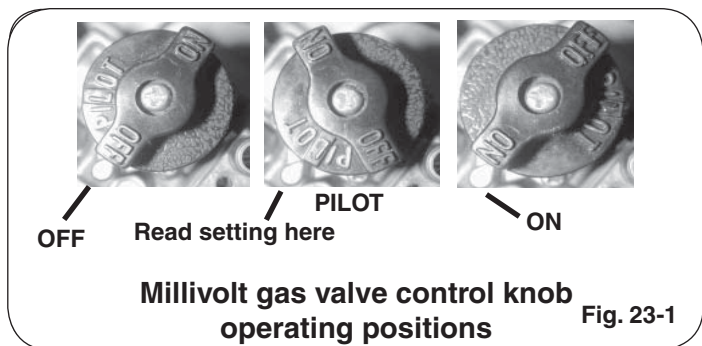

Your Real Fyre unvented gas log set is now ready for you to enjoy. Simply flip the control switch (Fig. 23-1) to the **ON** position. Then adjust the flame-height control knob as desired.

When you are finished enjoying your Real Fyre log set, flip your control switch (Fig. 23-2) to the **OFF** position. If total shutdown is desired, push the millivolt control knob in slightly and turn to the **OFF** position (Fig. 23-1). Your ODS pilot light will be extinguished.

When shutting your log set down, be sure to TURN THE FLAME COMPLETELY TO THE OFF POSITION. Allow the burner to remain completely off for 1 minute before relighting!

LIGHTING INSTRUCTIONS - SERIES 15 VALVE

FOR YOUR SAFETY, READ BEFORE LIGHTING

WARNING

If you do not follow these instructions exactly, a fire or explosion may result, causing property damage, personal injury, or loss of life.



Do not use this appliance if any part has been underwater. Immediately call for a qualified professional service technician to inspect the appliance and to replace any part of the control system and any gas control that has been underwater.

The Real Fyre burner system has an ODS pilot. When starting the ODS pilot, follow these instructions exactly.

BEFORE LIGHTING, smell all around the gas burner system area for gas. Be sure to smell next to the floor, as some gas is heavier than air and will settle on the floor. IF YOU SMELL GAS, FOLLOW THE INSTRUCTIONS ON P. 1.

Use only your hand to push in or turn the gas control knob. Never use tools. If the knob will not push in or turn by hand, don't try to repair it. Call a qualified professional service technician. Force or attempted repair may result in fire or explosion.

LIGHTING THE ODS PILOT



1. Turn the igniter control knob (Fig. 24-1) on the burner control valve assembly to the side of the burner pan counterclockwise  so that the narrowing part of the knob moves from the **OFF** position, slightly toward **IGN**, until reaching the stop.
2. Press the igniter control knob in and hold in for five seconds (only ODS pilot gas will flow).
3. Continue pressing in while turning the igniter control knob further counterclockwise  toward the **PILOT** position, until you hear a click. The click is an indication that the piezo igniter has been activated.

Note: If the spark from the piezo igniter does not light the ODS pilot, repeat steps 2 & 3 until the ODS pilot lights.

4. Continue to hold the igniter control knob in the **PILOT** position for 30 seconds after the ODS pilot has been lit to allow the thermocouple to detect the ODS pilot flame.



Note: The ODS pilot flame should always be present when the burner system is in operation, and should just envelop the tip of the thermocouple.

IGNITING THE MAIN BURNER

1. When the ODS pilot flame is stable, release the igniter control knob and turn counterclockwise  to the **ON** position to enable the main burner.
2. Turn the flame-height control knob (Fig. 24-3) counterclockwise  to the fully **ON** position

(Fig. 24-4) to ignite the burner at maximum BTU. After the main burner ignites, adjust the flame height as indicated below.

ADJUSTING THE FLAME HEIGHT

1. To adjust the flame, turn the flame-height control knob (Fig. 24-3) counterclockwise  to increase the flame height, or clockwise  to decrease the flame height, until the flames have the desired characteristics.
2. When you are finished enjoying your fire, turn the flame-height control knob to **OFF**. The ODS pilot will remain lit. The burner system can be relit by rotating the flame-height control knob toward **ON**.

SHUTTING OFF THE ODS PILOT

If you do not plan on using your burner system for an extended period, you may elect to extinguish the ODS pilot. To do this, rotate the flame-height control knob to the **OFF** position and then rotate the igniter control knob to the **OFF** position (Fig. 24-1).

Important: When shutting your burner down, be sure to TURN THE FLAME FULLY OFF (to **PILOT** or **OFF**). Make sure the burner is completely off for one minute before relighting.

If this unit was shipped with a remote, or if a remote system was installed later, read and follow the separate remote instructions to operate the burner remotely.

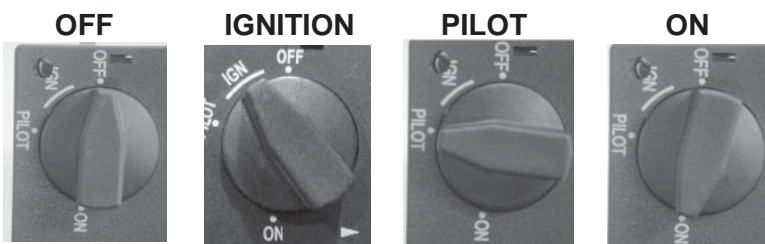

Gas valve operating positions

Fig. 24-1

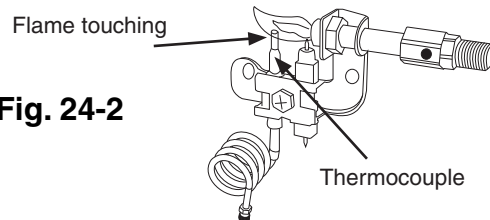

Fig. 24-2

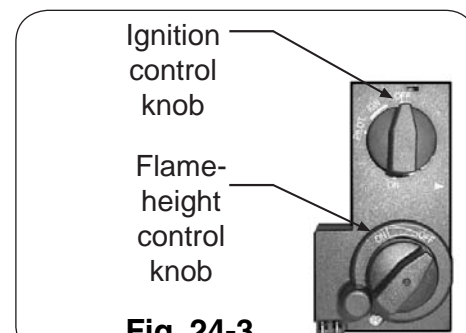

Fig. 24-3

Flame-height control knob



OFF



ON

Fig. 24-4

LIGHTING INSTRUCTIONS - MANUAL VALVE

FOR YOUR SAFETY, READ BEFORE LIGHTING

WARNING: If you do not follow these instructions exactly, a fire or explosion may result, causing property damage, personal injury, or loss of life.

Do not use this appliance if any part has been underwater. Immediately call for a qualified professional service technician to inspect the appliance and to replace any part of the control system and any gas control that has been underwater.

The Real Fyre burner system has an ODS pilot. When starting the ODS pilot, follow these instructions exactly.

BEFORE LIGHTING, smell all around the gas burner system area for gas. Be sure to smell next to the floor as some gas is heavier than air and will settle on the floor. **IF YOU SMELL GAS, FOLLOW THE INSTRUCTIONS ON P. 1.**

Use only your hand to push in or turn the gas control knob. Never use tools. If the knob will not push in or turn by hand, don't try to repair it. Call a qualified professional service technician. Force or attempted repair may result in fire or explosion.

LIGHTING THE ODS PILOT

1. Push in the gas control knob (Fig. 25-1) slightly and turn clockwise ↻ to **OFF**.

Note: The burner control knob cannot be turned from **PILOT** to **OFF** unless the handle is pushed in slightly. Do not force.

2. Turn the control knob on the gas valve counterclockwise ↺ to **PILOT**.

Note: The burner control knob cannot be turned from **OFF** to **PILOT** unless the handle is pushed in slightly. Do not force.

Wait five minutes to clear out any gas. If you then smell gas, **STOP!** Notify your gas supplier or the fire department immediately. If you don't smell gas, go on to step 2.

3. Push in on the control knob all the way and hold in. Immediately light the ODS pilot with a long-neck butane lighter or press in ignitor button (Fig. 25-1) to light the ODS pilot. Continue to hold the control knob in for approximately 30 seconds after the ODS pilot is lit. Release the knob, and it will pop back out. The ODS pilot should remain lit. If it goes out, repeat steps 4 through 5.
 - If the knob does not pop back out when released, stop and immediately call your service technician or gas supplier.
 - If the ODS pilot will not stay lit after several tries, follow the instructions for **SHUTTING OFF THE ODS PILOT** and call your service technician or gas supplier.

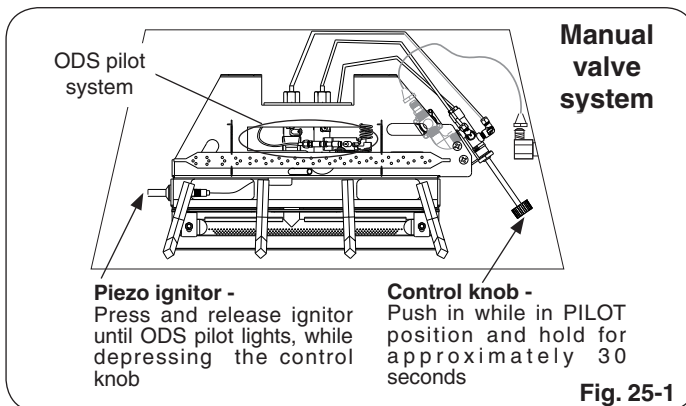

IGNITING THE MAIN BURNER

1. Push in slightly and rotate your manual control knob in a counterclockwise ↺ direction to the **ON/HIGH** position (first stop past **PILOT** position, see Fig. 25-2). The main burner will ignite at maximum BTU.

ADJUSTING THE FLAME HEIGHT

1. To lower the setting, push in slightly and continue to turn in a counterclockwise ↺ direction. When you reach the stop, your burner is at minimum **LOW** position.
2. To turn off *the main burners only*, push in slightly and rotate the manual control knob clockwise to the **PILOT** position. The **ODS pilot flame will remain lit**.

SHUTTING OFF THE ODS PILOT

If you do not intend to use your log set for an extended period of time, you may elect to turn the manual control knob to the **OFF** position. This will extinguish the ODS pilot. The next time you use the set, you will have to light the ODS pilot as described in **LIGHTING THE ODS PILOT**.

Note: When shutting your log set down, be sure to **TURN THE FLAME COMPLETELY TO THE OFF POSITION. Make sure the burner is completely off for one minute before relighting!**

If this unit was shipped with a remote, or if a remote system was installed later, read and follow the separate remote instructions to operate the burner remotely.

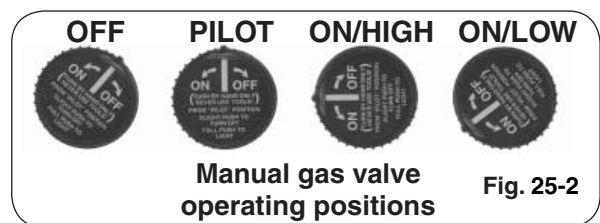

WARNING: NO ADJUSTMENTS ARE TO BE MADE TO THE ODS PILOT SYSTEM. TAMPERING WITH THIS SYSTEM CAN BE EXTREMELY HAZARDOUS.

Please use this page to record any information that you may want to have at hand.

TROUBLESHOOTING

- ONLY A QUALIFIED PROFESSIONAL SERVICE PERSON SHOULD SERVICE AND REPAIR THIS APPLIANCE.
- TURN OFF UNIT AND ALLOW TO COOL BEFORE TROUBLESHOOTING

1) BURNER SHUTTING DOWN DURING OPERATION

POSSIBLE CAUSE	SOLUTIONS
A. Insufficient or excessive gas pressure	<p>A1. Check gas pressure (Read E.- G. of IMPORTANT PRE-INSTALLATION AND FIREPLACE SAFETY INFORMATION section, & <u>check with local gas company</u>).</p> <p>A2. Other gas appliances may be on the same gas line, dropping gas pressure to the burner system. Check pressures with everything operating to ensure adequate pressure.</p>
B. Foreign debris in or around the fireplace and around the air intakes of the ODS pilot	B. Dust, carpet fibers, paper, spider webs, pet hair, etc. in fireplace or on burner assembly can affect operation of burner and ODS pilot assembly. Clean out debris and vacuum around burner for accumulated dust. Vacuum or use compressed air to clean out the ODS pilot assembly area, air shutter hole, burner orifice(s), and ODS pilot air intake openings. Blockage in this area will affect the operation of the ODS pilot assembly.
C. Room size (unconfined space)	C. 50 cu. ft. is required for every 1,000 BTU. Multiply the room's length x width x height by 20 (L x W x H x 20). If resulting number is less than the BTU rating of the burner, ODS pilot outages may occur. Provisions for adequate combustion and ventilation air must be made (see VENTILATION AND COMBINED SPACE SAFETY INFORMATION).
D. Flue area, fireplace, or damper dirty from soot	D. Clean around, above, and under damper thoroughly. Clean fireplace, removing loose material, including soot and creosote.
E. Fans, furnaces, air conditioning vents, returns, or fireplace outside air vents near or blowing into fireplace may create drafts, altering flame patterns	E. Eliminate drafts by closing heating and air conditioning vents, returns, and closing outside air vents. Fans blowing directly into the fireplace should be turned off when set is operating.
F. Blockages on burner	F. Vacuum any lava granules or material that may have fallen onto burner port area.
G. Fireplaces with high top cavities can accumulate by-products of combustion, which can start recirculating, causing shutdown	G. Open window or damper slightly. Move burner forward if possible, or otherwise increase ventilation.
H. Insufficient air circulation	H1. Check log placement, ember placement, bryte coals placement, and sizing of burner system (check your owner's manual for proper placement and requirements). Reposition burner closer to the front of fireplace. (Note: Do not place burner too close to combustibles.) (See INSTALLATION SAFETY GUIDELINES section.)
	H2. Check for sunken fireplace, excessive lava granules, or other accessories packed too tightly against burner or high bottom lip on glass door. Open window or damper slightly.
I. Fireplace too small for unit	I. Ensure minimum requirements are met (see FIREPLACE SIZE REQUIREMENT section).
J. At high altitude, too much heat or moisture can cause ODS pilot to shut down system	J. Open a window or the damper slightly or otherwise increase the ventilation. Your set may not be certified for use over 2,000 feet. Check your owner's manual.
K. ODS pilot flame lifting off thermocouple/generator	K. Check gas pressure (see section A1).
L. Pilot (remote-capable)	L. Contact your dealer for instructions on replacement.
M. Log placement	M. Your logs may have notches for correct placement. The burner may have brackets / pegs for correct placement. Make sure log set is placed in proper position (see LOG PLACEMENT) so there is no flame impingement on the log set.

TROUBLESHOOTING (Cont.)

POSSIBLE CAUSE

SOLUTIONS

2) ODS PILOT WILL NOT LIGHT

A. ODS pilot flame lifting off thermocouple/generator	A. Check gas pressure (see Section 1, A1 of this table).
B. Piezo spark not lighting ODS pilot	B. Check to make sure piezo is sparking when pressing / turning igniter. (Note: You may need to press / turn igniter several times to ignite ODS pilot.) See LIGHTING INSTRUCTIONS section.
C. Gas supply off/manual shutoff valve closed	C. Turn on gas supply or open manual shutoff valve.
D. Air in gas line	D. Hold control knob to bleed the line and repeat LIGHTING INSTRUCTIONS until air is removed.

3) HIGH CO - CARBON MONOXIDE DETECTORS IN HOME TURNING ALARM ON

A. High CO levels	A. TURN OFF UNIT IMMEDIATELY.
	B. Call a qualified professional service technician or your gas supplier.

4) CONDENSATION

A. High room humidity and cold walls or windows will create condensation in room	A. Open a window or damper slightly.
--	--------------------------------------

5) LOW FLAME HEIGHT

A. Low gas pressure	A. Check gas pressure (see Section 1, A1 of this table).
B. Household propane tank running low	B. Fill Tank completely.

6) BURNER NOT BURNING EVENLY

A. Top burner lights; bottom burner has delayed ignition or does not light	<p>A1. Check gas pressure. Can be caused by too small of a gas line (see Section 1, A1 of this table).</p> <p>A2. Low propane fuel gas level. Vacuum burner tube for soot blockage and fill propane tank.</p> <p>A3. Flash tube (if present) blocked. Clear blockage.</p>
B. Burner orifice(s) clogged	B. Clean burner orifice(s).

7) NO SPARK AT ODS PILOT WHEN IGNITER IS PRESSED / TURNED

A. Igniter electrode wire loose	A. Check wiring and reconnect any loose wiring
B. Igniter electrode positioned incorrectly	B. Contact your dealer for service

8) ODORS

A. New burner system (break-in period)	A. Burn unit for four to six hours with damper, doors, or windows open. Allow odors to dissipate.
B. Odors created by aerosol sprays, detergents, household chemicals, and insecticides	B. When these odors are drawn into the fireplace, this may cause objectionable odors. Thoroughly ventilate the area before restarting your burner system.
C. Gas leak	C. Locate gas leak and correct all leaks.
D. New home, new carpet, or new paint	D. When these odors are drawn into the fireplace, this may cause objectionable odors. Thoroughly ventilate the area before restarting your burner system.

TROUBLESHOOTING (Cont.)

POSSIBLE CAUSE	SOLUTIONS
9) SOOTING	
A. Low gas pressure	A. Check gas pressure (see Section 1, A1 of this table).
B. Drafts in room	B. Eliminate drafts by closing heating and air conditioning vents, returns, and outside air vents. Fans blowing directly into fireplace should be turned off when system is operating.
C. Air shutter(s) blocked	C. Burner air shutter(s) are blocked with debris. Vacuum debris in and around burner area.
D. Using a product other than Real Fyre gas logs with burner	D. Make sure only Real Fyre <u>vent-free</u> gas logs are used with your vent-free burner.
E. Using natural gas burner on propane gas or propane burner on natural gas	E. Make sure burner is set up for the gas you are using. Check nameplate attached to burner. Call your dealer immediately if nameplate does not match the gas you are using.
F. Adding any accessories to burner system	F. Shut down burner system and take off any accessories that do not belong with the system.
G. Blocked orifice(s) or air shutter(s)	G. Dust, lint, fibers, paper, spider webs, pet hair, etc. in the fireplace and on the burner assembly can affect the operation of the burner and the ODS pilot assembly. Clean out the debris and vacuum around burner for dust that may have accumulated over time. Vacuum the ODS pilot assembly and over the air shutter holes. Any blockages in this area will affect the operation of the ODS sensor. Remove and clean venturi tube if applicable.
H. Log placement	H. Some log sets have notches on the bottom front and rear logs to restrict any side-to-side movement. The log support/main burner brackets restrict any forward or backward movement. Make sure log set is placed in its proper position as instructed in the owner's manual, so there is no flame impingement on log set.
I. Too many embers on the ember burner (where fitted)	I. Remove any additional embers not included with your vent-free gas log set. Important: DO NOT ADD ANY ADDITIONAL EMBERS TO THIS LOG SET. ANY ADDITIONAL EMBERS MAY CAUSE UNSAFE OPERATION.

10) ODS PILOT WILL NOT STAY LIT WHEN KNOB IS RELEASED

A. Haven't held knob in long enough	A. Hold knob in for 1 minute and release. If the knob doesn't hold, contact your dealer for service (valve replace or new ODS).
-------------------------------------	--

11) WHISTLING NOISE COMING FROM BURNER

A. Burner may be cold or may have not been used for a prolonged period of time	A. Allow burner to warm up on low.
B. Air in gas line	B. Contact your gas company.
C. Clogged air openings	C. Clean all air openings.

12) POPPING NOISE COMING FROM BURNER

A. Flash tube blocked	A. Clear flash tube of all obstructions, especially around the bottom.
-----------------------	--

WARNING: If the gas quality is bad, the burners will produce soot and/or your pilot will not stay lit. Contact your gas company.

WARRANTY

PETERSON UNVENTED ROOM HEATER GAS APPLIANCE LIMITED WARRANTY

Robert H. Peterson Co. ("RHP") warrants your Real Fyre® unvented room heater gas appliance to be free from defects in material and workmanship.

Peterson unvented ceramic refractory gas logs are warranted for **as long as you own them (lifetime)**.

Peterson unvented burner component parts, except valves, ODS pilots, and controls, are warranted for **TEN (10) YEARS**. Peterson unvented outdoor stainless-steel burners are warranted for **FIVE (5) YEARS**.

Peterson glass, gems, and nuggets are warranted for **FIVE (5) YEARS**.

All Peterson valves, ODS pilots, and controls are warranted for **ONE (1) YEAR (excluding batteries)**.

A COPY OF YOUR SALES SLIP FOR PROOF OF PURCHASE IS REQUIRED

This warranty applies to the original purchaser for products which are installed in the United States or Canada and which are operated and maintained as intended for single family residential usage. This warranty is valid only with proof of purchase, shall commence on the date of purchase, and shall terminate (both as to original and any replacement products) on the anniversary date of the original purchase of the product stated on the above schedules.

This warranty covers defects in material and workmanship. This warranty **does not** cover parts which become defective as a result of negligence, misuse, use not in compliance with the Owner's Manual/Installation Instructions, accidental damage, improper handling, improper storage, improper installation, **lack of required routine maintenance** (as specified in the Owner's Manual/Installation Instructions), electrical damage, local gas impurities or failure to protect against combustibles. Product must be installed (and gas must be connected) as specified in the Owner's Manual/Installation Instructions by a **qualified professional installer**. Modifications to products which are not specifically authorized will void this warranty. Accessories, parts, valves, remotes, etc. when used must be Peterson products or this warranty is void. Warranted items will be repaired or replaced at Peterson's sole discretion. This warranty **does not** apply to rust, corrosion, oxidation, or discoloration unless the affected part becomes inoperable.

This warranty **does not** cover labor or labor related charges, except as provided by separate specific written programs from the Peterson Co. All repair work must be performed by a qualified professional service person and requires prior approval of Peterson.

Peterson may require the defective product or part to be returned to the factory to determine the cause of failure. Peterson will pay freight charges if the product or part is determined to be defective. This warranty does not cover breakage in shipment from our (Independent) distributor to its customer if the damage is determined to have occurred during that shipment.

This warranty specifically excludes liability for **indirect, incidental, or consequential damages**. Some states and provinces do not allow the exclusion or limitation of incidental or consequential damages, so the above exclusion may not apply to you. This warranty gives you specified legal rights, and you may have other rights that vary from state to state or province.

For additional information regarding this warranty, or to place a warranty claim, contact the R. H. Peterson dealer where the product was purchased.

**TO REGISTER YOUR PRODUCT ONLINE GO TO: WWW.RHPETERSON.COM,
AND CLICK ON PRODUCT REGISTRATION. THANK YOU FOR YOUR PURCHASE.**

WHEN USED IN THE COMMONWEALTH OF MASSACHUSETTS

**INSTALLATION OF THIS APPLIANCE MUST BE PERFORMED BY A MASSACHUSETTS
LICENSED PLUMBER OR GAS FITTER ONLY.**

**THE INSTALLATION OF THIS APPLIANCE MUST BE IN COMPLIANCE WITH 527 CMR
AND 248 CMR: BOARD OF STATE EXAMINERS OF PLUMBERS AND GAS FITTERS.**

This unvented gas appliance is designed for use in a standard wood-burning fireplace. It is designed to be used with an external wall switch or external remote thermostatic control system. Models with the suffix 12(P), 15(P), or 01V(P) are designed to be used with an external wall switch or an external remote wall thermostatic control system.

Quality Check

Date: _____

Burner Orifices	Nat.	L.P.	Leak Test:	_____	Model#:	_____
Main:	_____	_____	Burn Test:	_____	Serial#:	_____
Other:	_____	_____	Gas Type:	Nat. / L.P.	Air Shutter:	_____
					Inspector:	_____