

Models:

EC-2-24(P)
 EC-2-30(P)
 EC-2-36(P)
 EC-2-48(P)
 EC-2-60(P)

Log Set:

MP-(24,30,36,48,60)
 Mammoth Logs

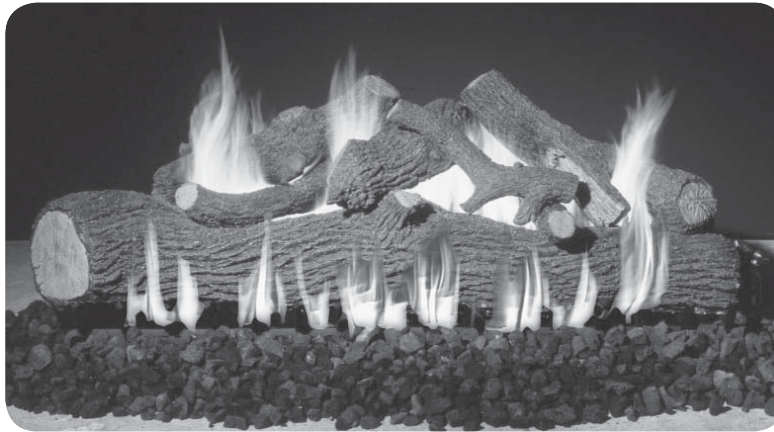

**COMPLIES to applicable
 ANSI standards for
 Vented Decorative
 Appliances**

**MANUALLY LIT
 BURNER
 SYSTEMS**

EPIC BURNER SEE-THRU GAS LOG SET

⚠ WARNING

If the information in this manual is not followed exactly, a fire or explosion may result, causing property damage, personal injury, or loss of life.

Do not store or use gasoline or other flammable vapors and liquids in the vicinity of this or any other appliance.

WHAT TO DO IF YOU SMELL GAS:

- Open a window.
- Do not try to light any appliance.
- Do not touch any electrical switch; do not use any phone in the building.
- Immediately call the gas supplier from a neighbor's phone and follow the gas supplier's instructions.
- If you cannot reach the gas supplier, call the fire department.

Installation and service must be performed by an NFI Certified or other qualified professional installer, service agency, or the gas supplier.

INSTALLER & CONSUMER:

These instructions MUST be retained with this appliance.

IMPORTANT: READ THESE INSTRUCTIONS CAREFULLY BEFORE STARTING INSTALLATION OF YOUR LOG SET

The Peterson Real Fyre gas log set is to be installed only in a solid-fuel burning fireplace with a working flue constructed of noncombustible material. Solid-fuels shall not be burned in a fireplace where this gas log set is installed. The installation, including provisions for combustion, ventilation air, and required minimum permanent vent opening, must conform with the *National Fuel Gas Code (ANSI Z223.1/NFPA 54)* and applicable local building codes. In Canada, the installation must conform with the *Natural Gas and Propane Storage and Handling Installation Code (CSA-B149.1)*. A damper clamp is included to maintain the minimum permanent vent opening and to prevent full closure of the damper blade. **The chimney damper should be fully opened when burning the log set. The log set is designed to burn with yellow flames; thus adequate ventilation is absolutely necessary.**



We recommend that our gas hearth products be installed and serviced by professionals who are certified in the U.S. by the National Fireplace Institute® (NFI) as NFI Gas Specialists.
www.nficertified.org

Important: For safe operation and proper performance of this product and to comply with certification, listings, and building code acceptances, use **ONLY** Peterson Real Fyre controls, parts, and accessories that have been specifically listed or certified for use with this burner system. Use of other controls, parts, or accessories is prohibited and will void all warranties, certifications, listings, and building code approvals, and may cause property damage, personal injury, and loss of life.

Table of Contents

3	PARTS LIST (24" - 30" MODELS)
4	PARTS LIST (36" - 60" MODELS)
5	FIREPLACE REQUIREMENTS
6	MINIMUM FREE OPENING AREA OF CHIMNEY DAMPER
6	INSTALLING THE DAMPER CLAMP
7	INSTALLATION
7	INSTALLING AND TESTING THE BURNER
7	ADJUSTING AIR MIXERS
7	PLACING THE LOGS
7	PLACING THE DECORATIVE LAVA ROCK
8	LOG PLACEMENT
10	MANUAL LIGHTING INSTRUCTIONS
11	LIGHTING INSTRUCTIONS - SPK-26 VALVE
11	FOR IMPROVED PILOT OPERATION
12	MAINTENANCE AND SERVICE
12	MAINTENANCE
12	SERVICE
12	FLAME APPEARANCE
13	TROUBLESHOOTING
14	WARRANTY

Parts List (24" - 30" models)

Before beginning installation, be sure the gas log set is complete by comparing its contents with this Parts List. Parts may differ depending upon the size of the set purchased. Be sure you know the model number and size of your set when ordering replacement or optional parts and accessories.

24" models

Item No.	Part No.	Description
1.	EC-2-24	Burner assembly
2.	CK-5-24SP	Connector kit
3.	DC-1	Damper clamp
4.	OCC-10	Lava Rock (qty of 3)
5.	MPL-24BF	Mammoth Pine front bottom log 24"
6.	MPL-24BF	Mammoth Pine front bottom log 24"
7.	MPL-15T	Mammoth Pine top log 15"
8.	MPL-20T	Mammoth Pine top log 20"
9.	MPL-17T	Mammoth Pine top log 17"
10.	BL-13T	Mammoth Pine top log 13"
11.	SPK-26	Safety Pilot kit (included w/ LP models only)

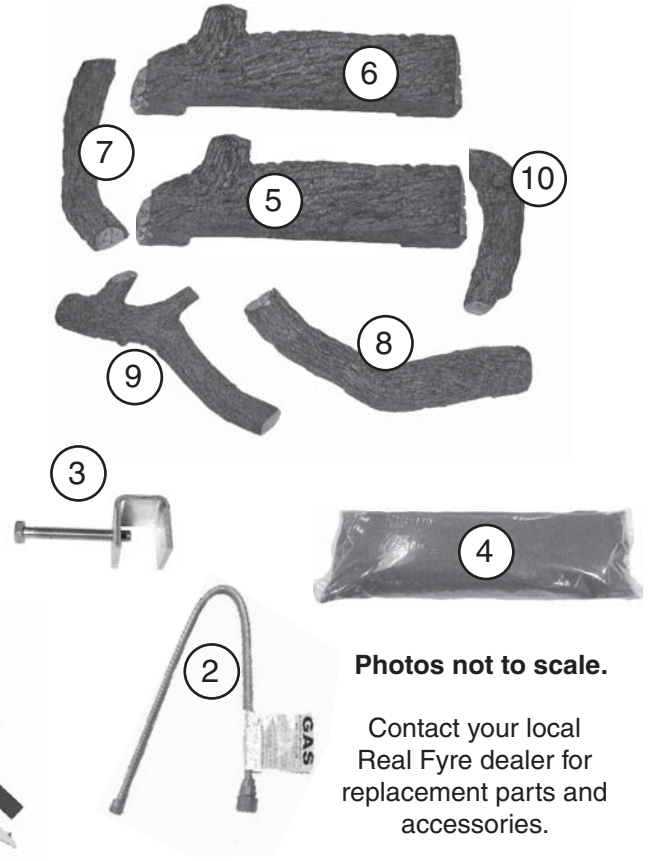

Photos not to scale.

Contact your local Real Fyre dealer for replacement parts and accessories.



30" models

Item No.	Part No.	Description
1.	EC-2-30	Burner assembly
2.	CK-5-24SP	Connector kit
3.	DC-1	Damper clamp
4.	OCC-10	Lava Rock (qty of 4)
5.	MPL-30BF	Mammoth Pine front bottom log 30"
6.	MPL-30BF	Mammoth Pine front bottom log 30"
7.	MPL-18T	Mammoth Pine top log 18"
8.	MPL-18TY	Mammoth Pine top log 18"
9.	MPL-20T	Mammoth Pine top log 20"
10.	MPL-17T	Mammoth Pine top log 17"
11.	SPK-26	Safety Pilot kit (included w/ LP models only)

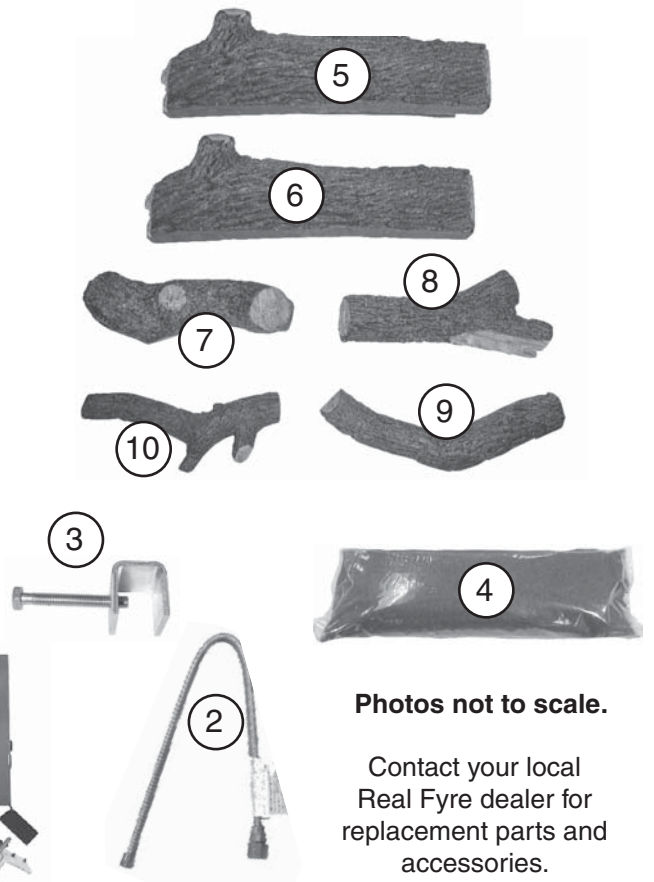

Photos not to scale.

Contact your local Real Fyre dealer for replacement parts and accessories.

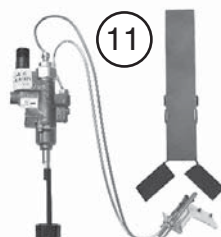

Parts List (36" - 60" models)

Before beginning installation, be sure the gas log set is complete by comparing its contents with this Parts List. Parts may differ depending upon the size of the set purchased. Be sure you know the model number and size of your set when ordering replacement or optional parts and accessories.

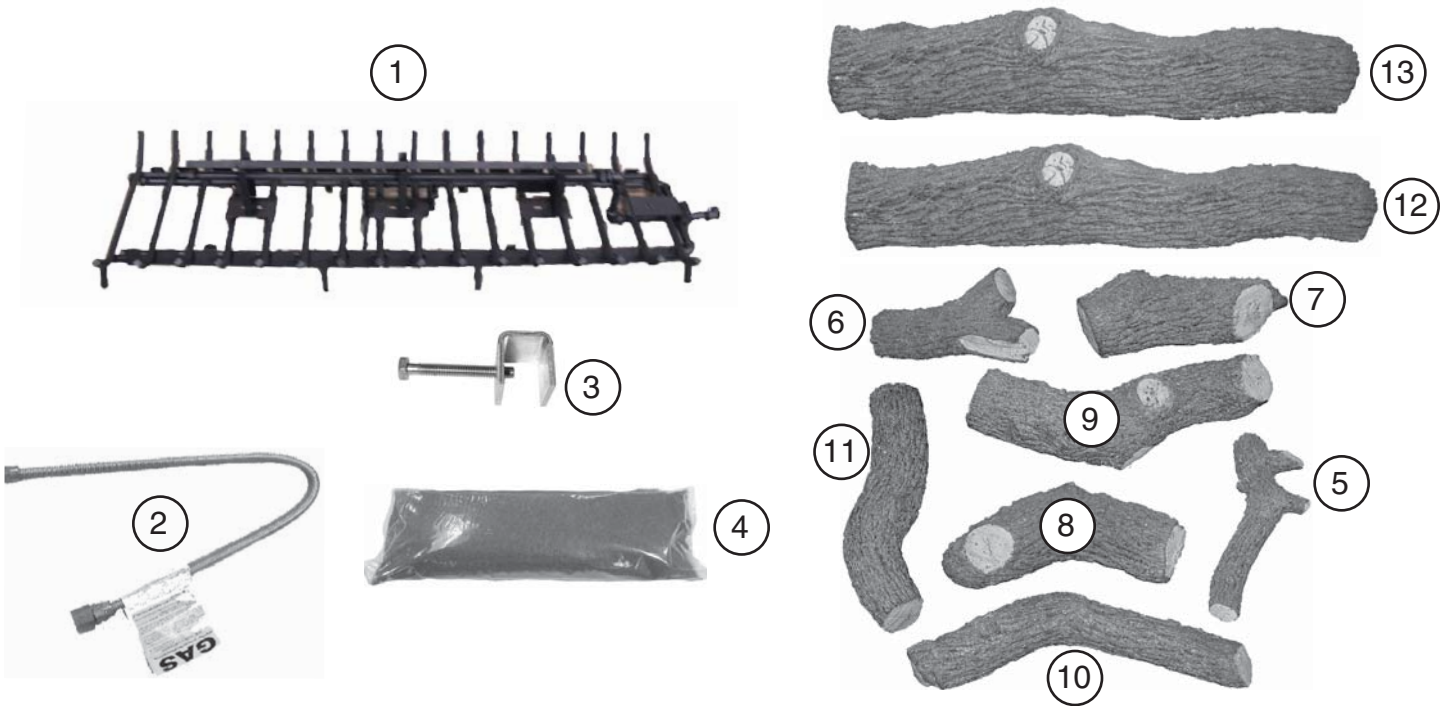

Item No.	Part No.	Description	60	48	36
1.	EC-2- 60	Valve, Pilot, Burner assembly	x	x	x
2.	CK-5-24SP or CK-5-18SP	Connector kit Connector Kit		x	x
3.	DC-1	Damper clamp	x	x	x
4.	OCC-10	Lava Rock (see right for qty)	6	5	4
5.	MPL-17T	Mammoth Pine top log 17"	x	x	x
6.	MPL-18TY	Mammoth Pine top 'Y' log 18"	x	x	x
7.	MPL-18T	Mammoth Pine top log 18"	x	x	
8.	MPL-19T	Mammoth Pine top log 19"	x	x	
9.	MPL-24T	Mammoth Pine top log 24"	x	x	
10.	MPL-21T	Mammoth Pine top log 21"	x		x
11.	MPL-20T	Mammoth Pine top log 20"	x	x	x
12.	MPL- 36 BF or MPL- 48 BF or MPL- 60 BF	Mammoth Pine front bottom log 36" Mammoth Pine front bottom log 48" Mammoth Pine front bottom log 60"			x
13.	MPL- 36 BF or MPL- 48 BF or MPL- 60 BF	Mammoth Pine front bottom log 36" Mammoth Pine front bottom log 48" Mammoth Pine front bottom log 60"	x	x	
14.	SPK-26	Safety Pilot kit (included w/ LP models only)	x	x	x

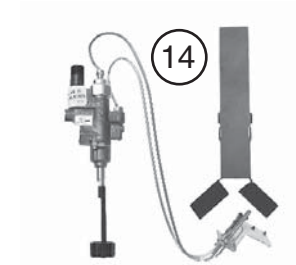

MP-60 shown.
Logs 8-11 are not included with all sets.
Photos not to scale.

Contact your local
 Real Fyre dealer for
 replacement parts and
 accessories.

Note: Values in ***bold Italics*** change with burner size and model log set.

Important Pre-installation Information

Check to be sure the fireplace meets venting and construction requirements for the installation of the Real Fyre gas log set (see FIREPLACE REQUIREMENTS section, below).

This burner may only be connected to natural gas.

Be sure the gas log set is properly sized for the fireplace. Improper sizing may negatively impact the proper drafting of the fireplace. Additionally, too large a log set will adversely affect the burn and hamper the proper operation of the control system. Fig. 5-1 illustrates the critical dimensions of the firebox.

This gas log set must be installed by an NFI Certified or other qualified professional installer. The installation, including provisions for combustion and ventilation air, must conform with local codes, or, in the absence of local codes, with the latest edition of the *National Fuel Gas Code, ANSI Z223-1*, and *NFPA54*.

Keep the appliance area clear and free from combustible materials, gasoline, and other flammable vapors and liquids.

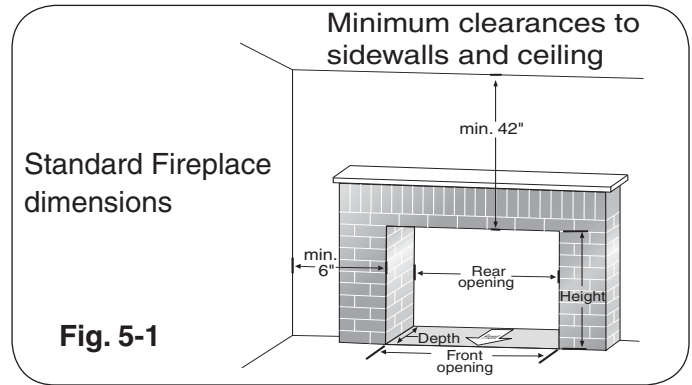

Fig. 5-1

Note: It is recommended that complete firebox dimensions be obtained to ensure proper sizing.

Model no.	Min. Fireplace Size			BTU* (x 1000)	
	Width	Depth	Height	Nat.	L.P.
EC-2-24	34"	24"	26"	90	90
EC-2-30	40"	24"	30"	110	110
EC-2-36	48"	30"	36"	190	180
EC-2-48	60"	30"	36"	215	190
EC-2-60	72"	30"	36"	260	190

*Nominal BTU based on gas inlet pressure. Nominal gas inlet pressure for natural gas is 5" W.C..

Important: To comply with building code acceptances, and for safe operation and proper performance of this log set, use **ONLY** Peterson Real Fyre parts and accessories. Use of other controls, parts, and accessories which are not designed for use with Real Fyre gas log sets is prohibited and will void all warranties, certifications, listings, and building code approvals, and may cause property damage, personal injury, or loss of life.

Fireplace Requirements

The Real Fyre gas log is to be installed only in a fully vented, fireplace with an open damper. The chimney must be free of any obstructions. The fireplace must be designed and approved to burn wood. The fireplace flue must be at least 8" at its smallest dimension.

The fireplace must have a gas supply line that has been installed by a qualified technician in accordance with all local codes. The gas supply line must be ½" minimum interior diameter. If the gas line to the fireplace is longer than 5', a larger diameter line may be necessary.

Be sure to clean the fireplace floor of any ashes or other foreign materials. It is recommended that the fireplace and chimney be inspected by a chimney sweep or other qualified person before you install the Real Fyre gas log set.

Required Gas Pressure: The minimum inlet gas supply pressure for the purpose of input adjustment is

5" of water column (w.c.) for natural gas. The maximum inlet gas supply pressure is 10.5" w.c. for natural gas.

Testing the Gas Supply System: The gas log set and its individual shut-off valve must be disconnected from the gas supply piping system while performing any tests of the piping system at pressures in excess of ½ psig. The gas log set must be isolated from the gas supply piping system by closing its individual manual shut-off valve during any pressure testing of the gas supply piping system at test pressures equal to or less than ½ psig. This is accomplished by closing the gas supply line valve required by NFPA 54. A fireplace screen must be in place when the appliance is in operation and, unless other provisions are provided, the screen shall have an opening(s) for introduction of combustion air. **When glass fireplace doors are used, operate the gas log set with the doors open.**

Minimum Free Opening Area of Chimney Damper

Minimum permanent free opening area of chimney damper for venting (sq. in.)					
For factory-built fireplaces					
Chimney height	24"	30"	36"	48"	60"
15'	46	52	96	109	136
20'	38	46	88	101	128
30'	29	38	79	92	119
For masonry-built fireplaces					
15'	61	72	106	119	146
20'	50	59	98	111	138
30'	45	53	89	102	129

Note: The minimum chimney height from hearth to top of chimney is 15'.

Installing the Damper Clamp

A damper clamp (See **Parts List**) is provided as a means to prevent full and/or accidental closure of the fireplace damper when installed as illustrated (Fig. 6-2). **When the gas log set is operating, the damper must be fully open.** To install the damper clamp:

1. Open the fireplace damper.
2. Place the damper clamp (Fig. 6-1) over the damper blade as in Fig. 6-2.
3. Tighten the set screw of the damper clamp with pliers or a wrench so that it affixes to the damper blade. The clamp must be permanently installed.
4. Should the damper clamp not fit, install a permanent damper stop or provide some other means of preventing full and/or accidental closure of the damper such as removing the damper blade.

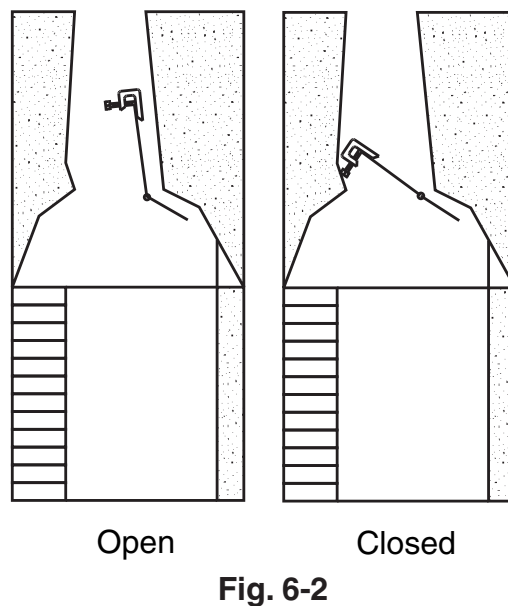
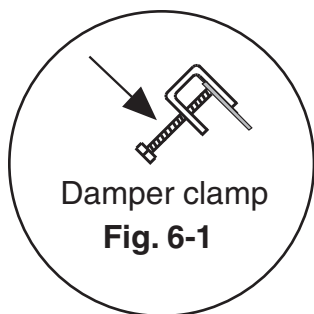

Installing and Testing the Burner

For Nat. Models:

1. Connect the gas flexible connector to the gas stub from the fireplace wall.
2. Place the assembled burner and grate into the center of the firebox.
3. Connect the other end of the gas flex connector to the burner.
4. LEAK TEST: Turn on the fireplace gas supply, and test at all connections for leaks using the appropriate soapy water solution. If bubbles appear, a leak is present. Turn off the gas and tighten at all connections. Repeat until no leaks are present. If a leak persists, turn off the gas supply and contact the local gas company or dealer. NEVER USE A FLAME TO CHECK FOR LEAKS.

For L.P. Models:

1. Install the provided SPK-26 pilot kit onto the nipple found on the right side of the burner (see Fig. 7-1). Be sure to use a pipe compound resistant to all gasses.
2. Remove (and save) the two screws found on the pilot assembly (Fig. 7-2). Discard the small bracket that comes loose, as it is not required for this install.
3. The rear of the burner assembly has two holes that allow for pilot assembly installation. Locate the pilot assembly over these holes, and use the screws from the previous step to fasten the pilot to the burner. See Fig. 7-3 for orientation.
4. Remove the small adapter that is loosely connected to the flex connector. Attach the adapter to the end of the SPK-26 valve using a pipe compound resistant to all gasses. Tighten securely. Then attach the open end of the flex connector to the adapter. Tighten securely.

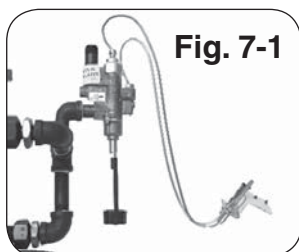

Fig. 7-1

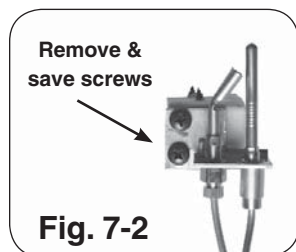

Fig. 7-2

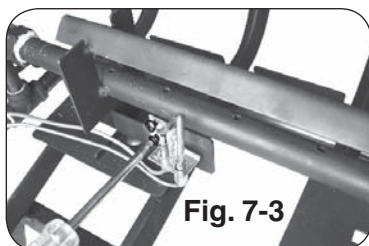

Fig. 7-3

5. Place the burner system in the fireplace. Center the burner in the fireplace.
6. Remove the large adapter that is loosely connected to the other end of flex connector. Attach the adapter to the gas-supply stub using a pipe compound resistant to all gasses. Tighten securely. Then attach the open end of the flex connector to the adapter. Tighten securely.
7. Place the heatshield over the valve. Check for leaks as instructed under #4 of the previous nat. gas install section.

Adjusting Air Mixers

Burners are equipped with air mixers for the upper (except 60") and front burners. Adjust the size and color of the flame by opening (turn outward) or closing (turn inward) as shown in Fig. 7-4 and Fig. 7-5.

Placing the Logs

CAUTION: Logs are heavy! Safely moving the front or back logs requires two or more people (see Fig. 8-3)

1. Place the front log on the grate in front of the burner pipe with the flat down and the heat chambers toward the burner pipe and the log as far forward as possible while keeping the back parallel with the burner pipe (Fig 8-2). Repeat for the second front log on the opposite side of the see-thru burner.
2. Place top logs across the front and back logs in the order and positions shown for your particular log set size on p. 8-9.

Placing the Decorative Lava Rock

Locate the bag of lava rock and pour its contents around the base of the grating in an attractive pattern. Do not place the Lava Rock on the logs or grate.

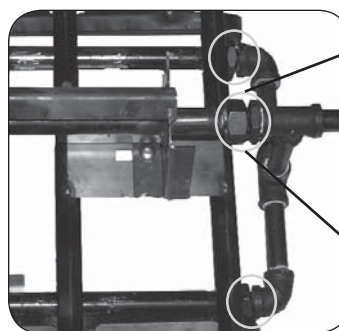

Fig. 7-4

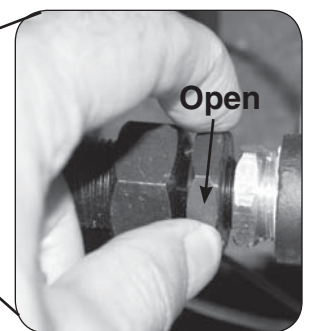

Fig. 7-5

Log Placement

Note: Reference the Parts List on page 4 for Figures 8-1 thru 8-8.

Fig. 8-1



Place the burner system

Fig. 8-2

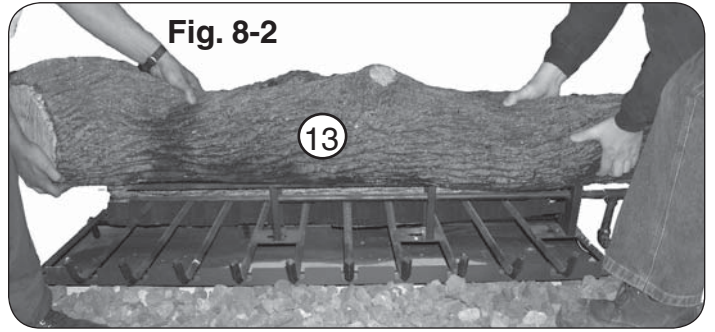

Place front bottom logs (requires at least two to lift)

Fig. 8-3

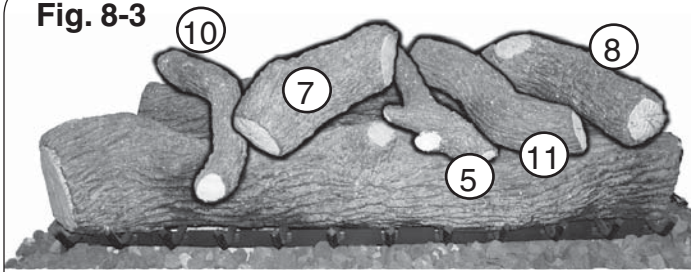

60" setup A

Fig. 8-4

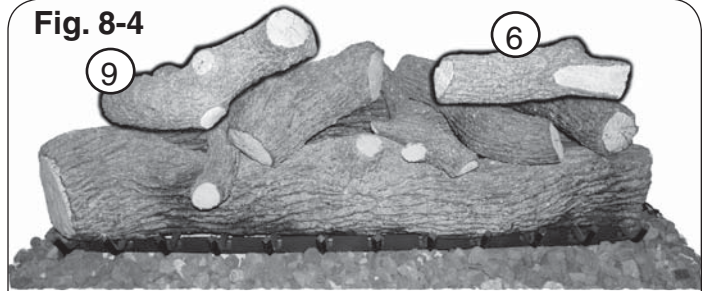

60" setup B

Fig. 8-5

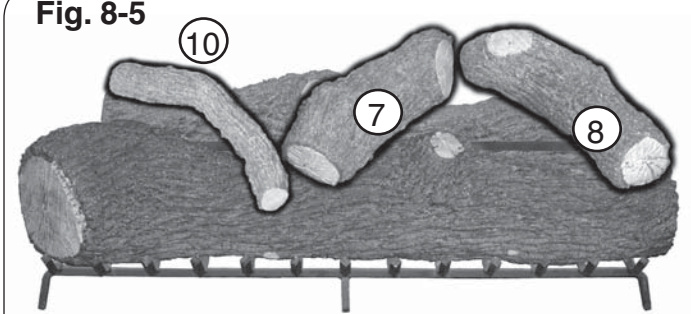

48" setup A

Fig. 8-6

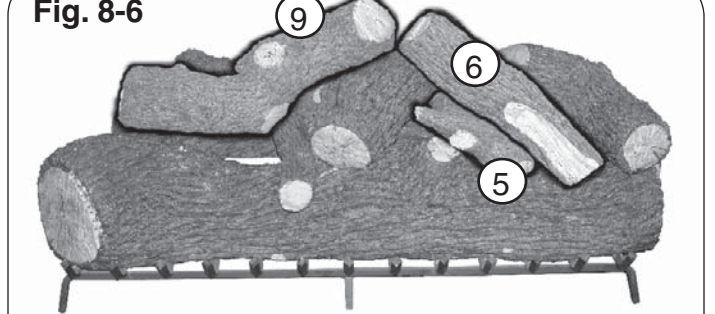

48" setup B

Fig. 8-7

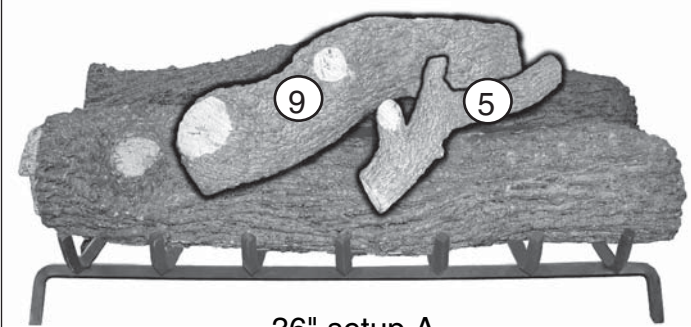

36" setup A

Fig. 8-8

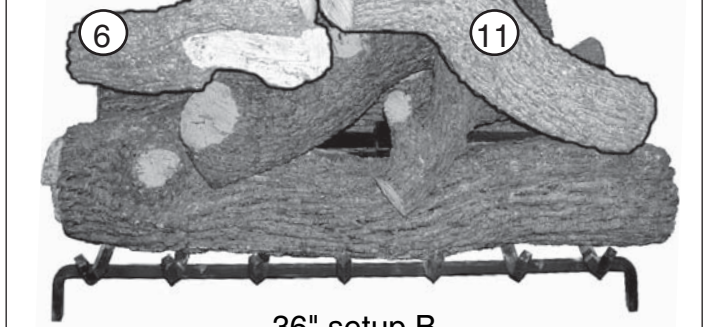

36" setup B

Log Placement (cont.)

Note: Reference the Parts List on page 5 for Figures 9-1 thru 9-4.

Fig. 9-1

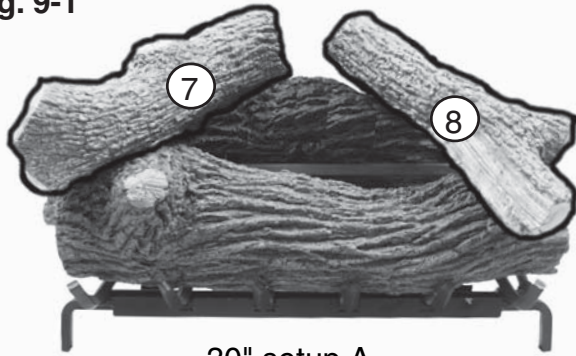

30" setup A

Fig. 9-2

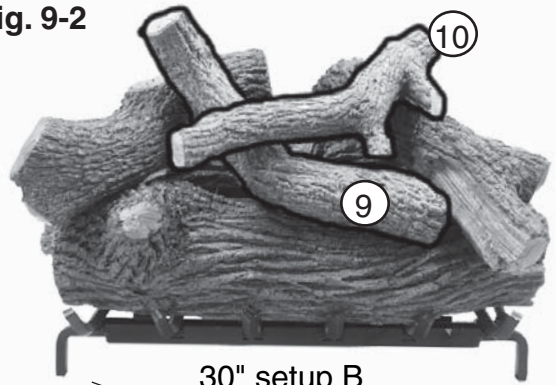

30" setup B

Fig. 9-3

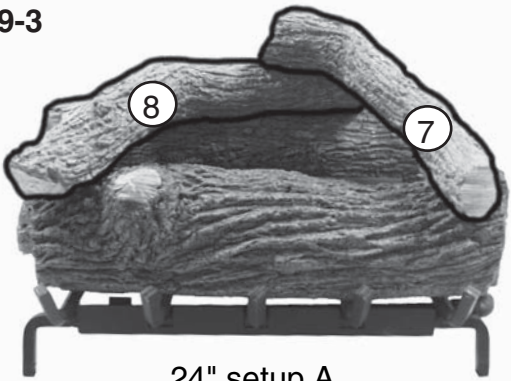

24" setup A

Fig. 9-4

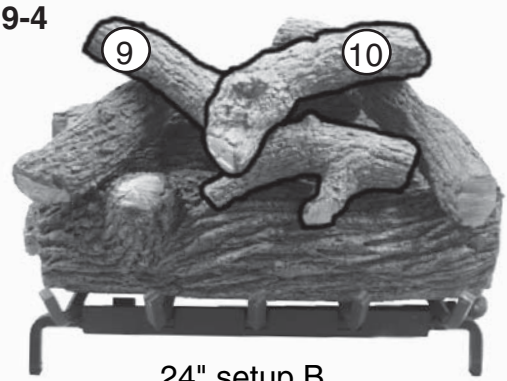

24" setup B

Manual Lighting Instructions

FOR YOUR SAFETY, READ BEFORE LIGHTING

WARNING: If you do not follow these instructions exactly, a fire or explosion may result causing property damage, personal injury or loss of life.

Do not use this appliance if any part has been underwater. Immediately call for a qualified professional service technician to inspect the appliance and to replace any part of the burner system which has been under water.

BEFORE LIGHTING, smell all around the burner area for gas. IF YOU SMELL GAS, FOLLOW THE INSTRUCTIONS ON THE COVER (P. 1).

Lighting and Extinguishing the Burner System

1. Place a lighted long-stem match near the right end of the top burner (**do not hold the match in your hand**) or use a lighted long-necked butane lighter (Fig. 10-1).
2. Slowly turn the fireplace remote valve to the **ON** position. The log set should light.
3. If the log set does not light before the match goes out, immediately turn the valve to the **OFF** position.
4. Wait approximately five (5) minutes to clear out any gas, and repeat steps 1-3 above.
5. If the log set fails to light again, turn off the valve and contact the dealer or gas supplier.
6. To extinguish the Real Fyre gas log set, simply turn the valve to the **OFF** position. Be sure the valve is turned fully off to avoid any gas leakage.

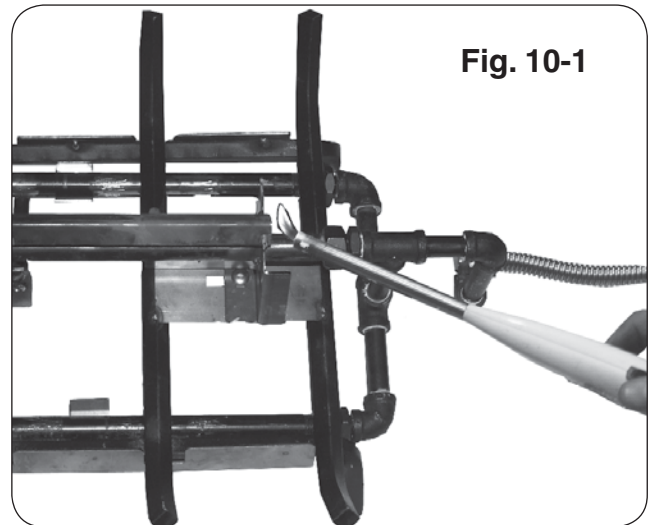

Fig. 10-1

Cleaning and Checking

A periodic check of the following should be performed at least annually by a qualified professional service representative.

1. Flue system for proper venting.
2. Damper operation
3. Orifices for dirt or other foreign matter.
4. Visual check on the burner.
5. Air mixers for dust/lint blockage.
6. Excessive soot on logs.

Lighting Instructions - SPK-26 Valve

* We recommend that before you install the burner you familiarize yourself with the control valve layout. This will help you to be confident operating the burner when fully installed (see figures below for typical control positions).

HOW TO LIGHT THE PILOT

To light the pilot from the **PILOT** position (Fig. 11-2), push in slightly on the knob and turn to the **OFF** position (Fig. 5-1). Wait five minutes, then turn the knob to the **PILOT** position (Fig. 11-2). Push the knob fully in and at the same time place a long lighted match or long necked lighter at the pilot burner. The pilot should light. Hold the knob in approximately 60 seconds. If the pilot does not stay lit, turn to the full **OFF** position (Fig. 5-1). Wait five minutes and repeat the LIGHTING INSTRUCTIONS.

HOW TO TURN THE GAS BURNER ON AND OFF USING THE SAFETY PILOT KIT

BE SURE THE DAMPER IS FULLY OPEN WHEN OPERATING THE GAS BURNER.

TO TURN ON THE GAS BURNER FROM THE PILOT POSITION: When the pilot is lit (Fig. 11-2), turn the knob 90° counter-clockwise to the **ON** position (Fig. 11-3).

TO TURN OFF THE GAS BURNER FROM THE ON POSITION (Fig. 11-3): Turn the knob 90° clockwise to the **PILOT** position (Fig. 11-2).

TO TURN OFF THE GAS BURNER AND THE PILOT FROM THE PILOT POSITION (Fig. 11-2): Push in slightly on the knob and turn 90° clockwise to the **OFF** position (Fig. 5-1).

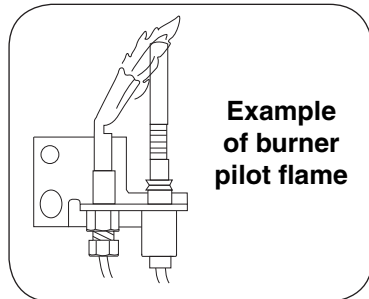

Read here



1. Use OFF only when complete shutdown is necessary.

Fig. 11-1
OFF position
Burner off - pilot off

Read here



2. Turn dial to PILOT position. With match ready, press knob in and hold for 60 seconds while lighting pilot.

Fig. 11-2
PILOT position
Burner off - pilot on

Read here



3. Turn knob to ON to light burner.

Fig. 11-3
ON position
Burner on - pilot on

For Improved Pilot Operation

PILOT ADJUSTMENT

Should the pilot require adjustment, the following steps should be taken: With the pilot lit and the control knob in the pilot position, use a long narrow screw driver and turn the pilot adjustment screw slowly clockwise to reduce the pilot flame or counter-clockwise to increase the flame (Fig. 11-4). The adjustment screw can be turned so that the pilot flame is completely extinguished. Some tightening of the screw may occur during adjustment; this is normal. The pilot flame should be a soft blue color with slightly yellow tipping which encircles the thermocouple tip.

Turn the control knob to the **ON** position to assure proper ignition of the log burner.

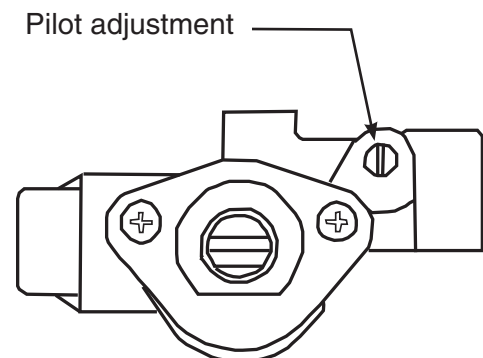

Fig. 11-4

Maintenance and Service

Maintenance

Once installed and operating properly, the Real Fyre gas log set requires very little maintenance. You should inspect the log set and control annually for the following:

- 1. Excessive Sooting** - Some sooting of the log set is normal and adds to the natural appearance of burned wood. If soot accumulates, you may brush the soot off with a stiff brush. Logs may also be cleaned by allowing them to heat up, then spraying them with water where soot has accumulated.
- 2. Insects and burner blockage** - Check the burner ports and the air-mixer, if present, to make sure they are free from debris. Blocked burner ports and orifices may result in poor flame distribution or flame at air-mixer (if equipped).

Service

It is recommended that a qualified professional service technician be called to service the gas log set and control should service be required. The **Troubleshooting** section of these instructions serves as a guide for ensuring optimum performance of the gas log set.

Flame Appearance

The flames should be blue at the base and a combination of blue/yellow at the body and tips.

Troubleshooting

For Nat and LP Models:

PROBLEM	CAUSE	SOLUTION
1. Log set Not burning properly	a. Low flame/uneven flame.	a. Check for low gas pressure; minimum operating pressures of 5" W.C. at manifold.
2. Excessive soot on logs	a. Yellow flame impingement	a. Open air shutter on front burner or main burner as needed.

For LP Models Only:

PROBLEM	CAUSE	SOLUTION
1. Pilot will not light	<ul style="list-style-type: none"> a. Obstruction in pilot gas supply/pilot gas supply line is kinked b. Inadequate gas supply c. Pilot out of adjustment d. Air in line 	<ul style="list-style-type: none"> a. Clear out obstruction. Replace pilot gas supply line if kinked b. Have gas pressure checked by installer or gas supplier c. Adjust pilot (see page 5) d. Air should clear, attempt to relight
2. Pilot will not stay lit after releasing knob	<ul style="list-style-type: none"> a. Pilot flame out of adjustment (tip of the flame should encircle tip of the thermocouple) b. Thermocouple (SPK) either too tight or too loose c. Bad thermocouple 	<ul style="list-style-type: none"> a. Adjust pilot (see page 5) b. Thermocouple should be finger tight and then 1/8" turn with a wrench c. Replace thermocouple
3. Burner extinguishes a few minutes after lighting.	a. Inadequate gas supply causes pilot flame to reduce after burner lights	a. Using pilot adjustment, increase gas to pilot. Pilot flame must be in contact with the thermocouple tip
4. Burner extinguishes after burning for some time (approximately 10 minutes to 1 hour)	<ul style="list-style-type: none"> a. Thermocouple has overheated; glass doors are closed b. Thermocouple has overheated; insulation pad is not in place c. Thermocouple has overheated; burner flames are heating the thermocouple cold junction 	<ul style="list-style-type: none"> a. Be sure glass doors are open during operation b. Be sure that the insulation pad is in place between the burner pan and the pilot bracket c. Be sure the pilot assembly and the flame diverter are in their proper position. Rearrange logs so that flame is not deflected to the thermocouple
5. Pilot will light without holding in knob or gas flows to burner without pilot being lit	a. Valve is installed backward	a. Reinstall valve with inlet port attached to gas supply and outlet port attached to burner

If you still experience problems with the SPK-26 safety pilot kit, please contact a local Peterson dealer.

WARRANTY

PETERSON VENTED DECORATIVE GAS APPLIANCE LIMITED WARRANTY

Robert H. Peterson Co. ("RHP") warrants your Real Fyre® vented decorative gas appliance to be free from defects in material and workmanship.

Peterson vented ceramic refractory gas logs are warranted for **as long as you own them (lifetime)**.

Peterson vented burner assemblies are **WARRANTED for TEN (10) YEARS**. Peterson vented outdoor stainless-steel burner assemblies are warranted for **FIVE (5) YEARS**.

Peterson glass, gems, nuggets, and fiber-ceramic blend gas logs are warranted for **FIVE (5) YEARS**.

SPK-26 controls are warranted for **THREE (3) YEARS**.

APK-17 controls (including -17 valve) are warranted for **TWO (2) YEARS**.

All other Peterson valves, pilots, and controls are warranted for **ONE (1) YEAR (excluding batteries)**.

A COPY OF YOUR SALES SLIP FOR PROOF OF PURCHASE IS REQUIRED

This warranty applies to the original purchaser for products which are installed in the United States or Canada and which are operated and maintained as intended for single family residential usage. This warranty is valid only with proof of purchase, shall commence on the date of purchase, and shall terminate (both as to original and any replacement products) on the anniversary date of the original purchase of the product stated on the above schedules.

This warranty covers defects in material and workmanship. This warranty **does not** cover parts which become defective as a result of negligence, misuse, use not in compliance with the Owner's Manual/Installation Instructions, accidental damage, improper handling, improper storage, improper installation, **lack of required routine maintenance** (as specified in the Owner's Manual/Installation Instructions), electrical damage, local gas impurities or failure to protect against combustibles. Product must be installed (and gas must be connected) as specified in the Owner's Manual/Installation Instructions by a **qualified professional installer**. Modifications to products which are not specifically authorized will void this warranty. Accessories, parts, valves, remotes, etc. when used must be Peterson products or this warranty is void. Warranted items will be repaired or replaced at Peterson's sole discretion. This warranty **does not** apply to rust, corrosion, oxidation, or discoloration unless the affected part becomes inoperable.

This warranty **does not** cover labor or labor related charges, except as provided by separate specific written programs from the Peterson Co. All repair work must be performed by a qualified professional service person and requires prior approval of Peterson.

Peterson may require the defective product or part to be returned to the factory to determine the cause of failure. Peterson will pay freight charges if the product or part is determined to be defective. This warranty does not cover breakage in shipment from our (Independent) distributor to its customer if the damage is determined to have occurred during that shipment.

This warranty specifically excludes liability for **indirect, incidental**, or consequential damages. Some states and provinces do not allow the exclusion or limitation of incidental or consequential damages, so the above exclusion may not apply to you. This warranty gives you specified legal rights, and you may have other rights that vary from state to state or province.

For additional information regarding this warranty, or to place a warranty claim, contact the R. H. Peterson dealer where the product was purchased.

When contacting your Peterson dealer or the R. H. Peterson Co., please provide the following information:

- Your name, address, telephone number, e-mail
- Sales receipt showing where purchased and date purchased
- Model number, serial number of product, date code
- Relevant information: installer, additions, repairs, when defect was first noted

**TO REGISTER YOUR PRODUCT ONLINE GO TO: WWW.RHPETERSON.COM,
AND CLICK ON PRODUCT REGISTRATION. THANK YOU FOR YOUR PURCHASE.**

Quality Check		Date: _____	
Burner Orifices	Nat. _____	Leak Test: _____	Model#: _____
Main:	_____	Burn Test: _____	Serial#: _____
Other:	_____	Gas Type: <u>Nat.</u> _____	Air Shutter: _____
			Inspector: _____